

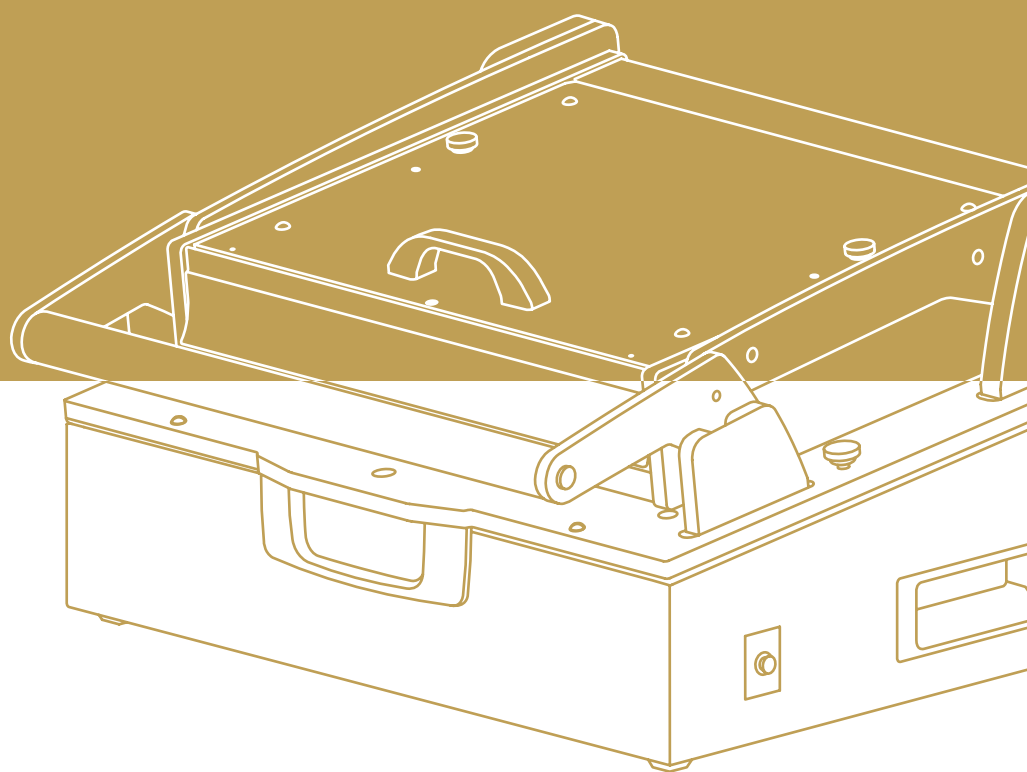

ingun[®]
Test Probes · Test Fixtures

Test Fixtures Catalog 2013/2014



Quality through Precision

Test Probes



Test Probes: The highprecision Test Probes are the heart of every test. With more than 20,000 variants in more than 400 series INGUN provides the largest assortment worldwide; from a standard Test Probe to an individually manufactured Test Probe.

The Radio-Frequency Probes are listed in a separate Catalog. There you can find directly

the suitable RF-Probes via a Jack/Plug Register.

Test Fixtures

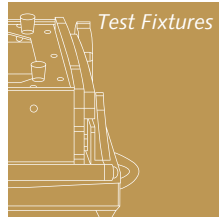

Test Fixtures: Mechanical, pneumatic and vacuum-operated Test Fixtures as well as special customized contacting units are developed and manufactured by INGUN for all common Test Systems. The strength lies in special Test Fixture design and build, because over 40 years of experience provides sophisticated and extraordinary solutions.

INGUN plays a special role in regard to verify the quality of Test Fixtures. These can be checked at various manufacturing stages with the use of an optical measuring machine. A unique service!

Contents

INGUN Test Fixtures	Page	1
INGUN sets the standard in Quality Assurance	Page	2
Your demands – our solutions	Page	3
Your Contact Partner	Page	4–5
Standard Test Fixtures	Page	6–55
Contents	Page	6
Manual Test Fixtures	Page	7–28
Pneumatic Test Fixtures	Page	29–33
Vacuum Test Fixtures	Page	34–55
Accessories (Excerpt)	Page	56–61
Contents	Page	56
Special Fixtures	Page	62–76
Contents	Page	62
INGUN Test Fixtures and Accessories/Manual Test Fixtures according to Series	Page	77

INGUN Test Fixtures – large range of Standard Fixtures and strong with special solutions



Market leader in Test Equipment design and build

INGUN Prüfmittelbau GmbH develops and manufactures Test Equipment for the electronic industry since 1971. Apart from Test Probes, INGUN also designs and manufactures numerous types of Test Fixtures at the Lake of Constance in Germany. Renowned customers trust the high quality standard and value the flexibility – especially in regard to customized special solutions.

Experienced engineers and technicians apply their know-how and address even the most unusual demands directly: From the project design through to after-sales service.

Innovative ideas are born in our R&D dept. and these ideas lead to optimization and completely new solution possibilities.

Manufacturing with state-of-the-art technologies

In accordance to the INGUN-motto “Quality through Precision” high-quality Fixtures are created. INGUN uses CAD Test Fixture Design and the most modern CNC-controlled drilling and milling machines and machining stations. Furthermore, a multi-sensor coordinate measuring machine for checking the production stages is used. Wiring verification and stress measurement tests of PC-Boards round up the range of INGUN services.

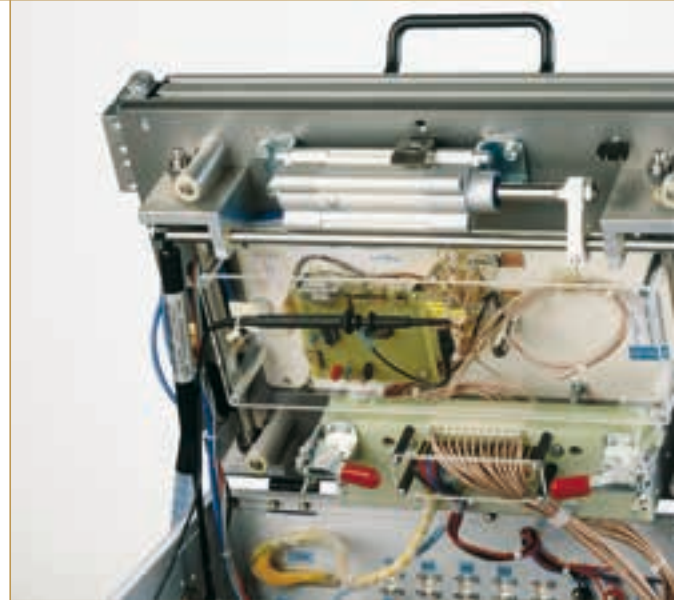

INGUN Test Fixtures for all common Test Systems and Interfaces:



INGUN sets the standard in Quality Assurance

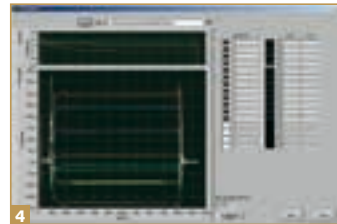
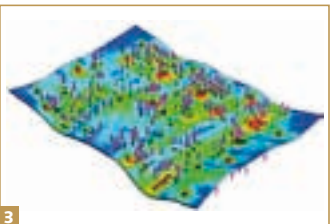
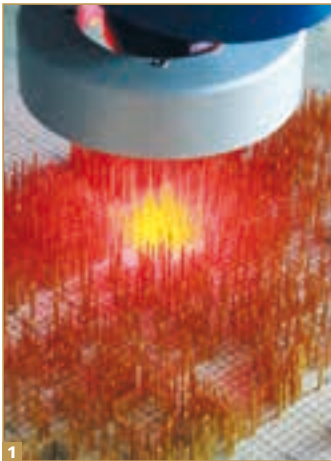

According to our slogan „Quality through Precision“ we set standards in the quality assurance with the most modern test- and measurement instruments for an excellent and environmentally compatible quality of Test Fixtures.

1 Multi-sensor Coordinate Measurement Machine

- Testing of positional accuracy of spring-loaded Test Probe and the contact quality of punctures in test points
- Testing at INGUN Test Fixtures and other less known Test Fixtures

2 Wiring Tester

- Fully automated Testing
- Identification of incorrect wiring and of short circuits

3 FE-Analysis

- Analysis of units before start of manufacturing
- Analysis of the theoretical heavy stress load of the units under mechanic pressure

4 DMS-Analysis

- Analysis of units after manufacturing
- Measurement of real stress load of units while contacting

Environment

Environmental Laws and Regulations have the aim to protect both human health and the environment on a high level. Environmentally friendly business decisions lead our acting.



Certification

Since 1995 INGUN has had a QM system according to ISO 9001 uninterruptedly. Satisfaction of our customers is our focus.



Certified according to ISO 9001



Our Test Fixtures are designed in accordance to the current conformity assessment procedures of the directive 2006/42/EG and the low-voltage directive 2006/95/EG.

Your demands – our solutions

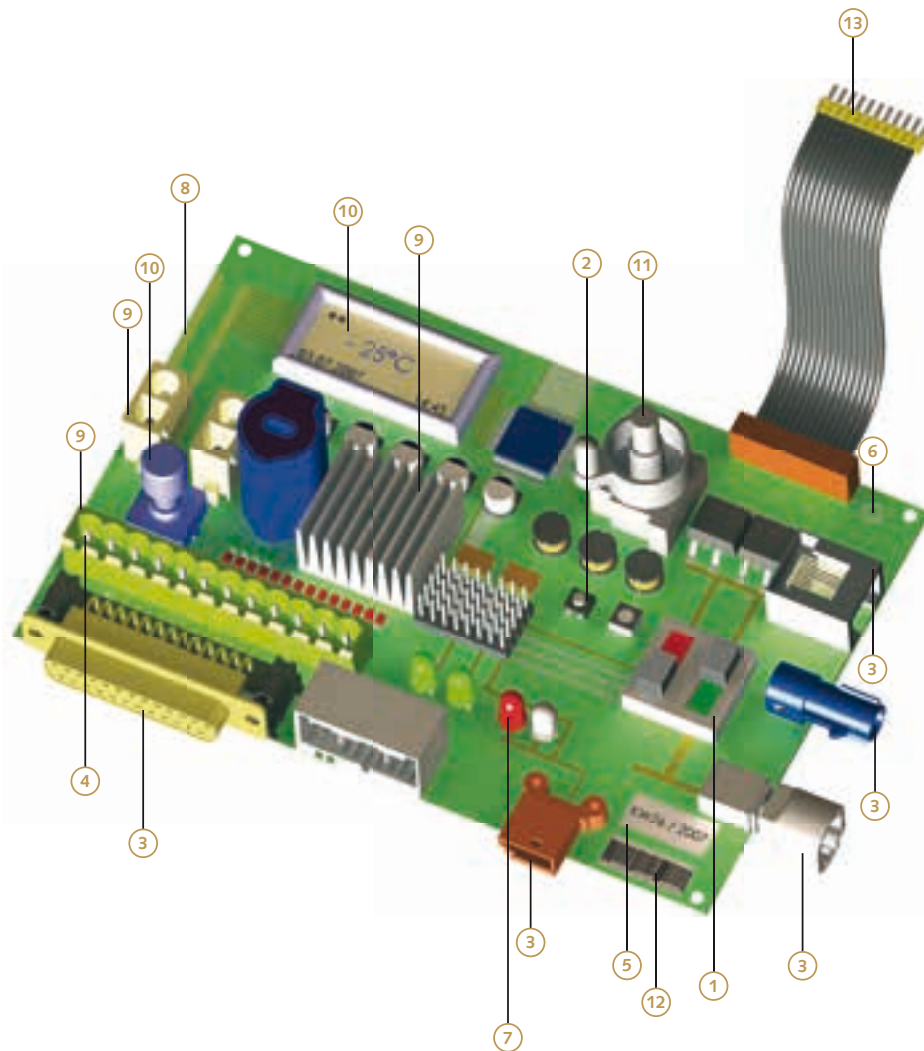

- ① Key, Button & Pusher Operation
- ② Poti-adjustment
- ③ Contacting Connectors with large location tolerance/floating, self-centring Contact Head
- ④ Connector contacting
- ⑤ "Good" Marking via Check Marker Unit (PZS)
- ⑥ "Good" Marking (pneumatic, mechanical)
- ⑦ LED-check
- ⑧ Top-side contacting
- ⑨ Component recognition/Code recognition/Location recognition for connectors
- ⑩ Display check
- ⑪ Automatic poti-adjustment with electrical screwing tool
- ⑫ Mechanical barcode reader bracket for barcode label
- ⑬ Contacting of cable ends

Common Abbreviations:

ADP	Pressure Plate	KRM	Contact Cleaning Mat	S-10	Interface for 10 Blocks
ATS	Replacement Kit	KS	Receptacle	SAM	Connector Approach Mechanism
D	Desk-top Housing	KT	Contact Terminal	-E	Europe Format
DKS	Rotating Test Probe	KTC	Wiring Guard	-DE	Double-Europe Format
EXS	Eccentric Pin	KTE	Probe Plate Unit	-TE	Triple-Europe Format
F	Flat Housing	KTP	Probe Plate	SKS	Switching Probe
FE	Spring	LWL	Optical Wave Guide	TP	Test-Point
FED	Counter-pressure Spring	MA	Manual Test Fixture	TKS	Thermo Test Probe
FKT	Functional Test	NDH	Pressure Frame	UKS	Rigid Test Probe
FS	Tooling Pin	PA	Pneumatic Test Fixture	VA	Vacuum Test Fixture
GFS	Spring-loaded Tooling Pin	PAS	PCB Support Disk	VIN	Interchangeable Vacuum Fixture
GKS	Spring-loaded Test Probe	PAZ	Pneumatic Test Fixture with gear-wheel drive	VK	Vacuum-cassette
HBS	Stroke limiting Disk	PKS	Pneumatic Test Probe	VSN	Rigid-Pin Test Fixture
HFS	RF Test Probe	PRA	PCB Support Pin	WPL	Interchangeable Plate
HG	Tall Housing	RC	Receiver	ZSK	Additional Contacting Unit
HSS	High-current Test Probe	S-5	Interface for 5 Blocks	ZW	Extraction Tool
ICT	In-Circuit-Test	S-7	Interface for 7 Blocks		
KB	Interface Block				

Your Contact Partner

We will be pleased to develop and design the individual Test Fixture concept to meet your testing demands. Convince yourself of our many years of know-how – both in regard to standard versions and especially in regard to special Test fixtures. Being Europe's largest Test Fixture manufacturer, our large number of machines and employees enables us to solve even the most complex testing demands within the shortest period of time.

Furthermore, we have the largest assortment of Test Probes worldwide and therefore we always have the right solution for the assembly and customizing of our Test Fixtures. Contact one of our competent contact persons!

Tel +49 7531 8105-0

Fax +49 7531 8105-65

info@ingun.com

www.ingun.com



- | | |
|---|---|
| 1 Supervisory Board
Wolfgang Karl | 5 Reception
Gabriele Seifritz |
| 2 Managing Director
Armin Karl | 6 Head of Export Sales
Katharina Hunke |
| 3 Commercial Director
Jochen Müller | 7 Head of Sales
D/CH/Benelux
Sigfrid Nagel |
| 4 Technical Director
Michael Eisele | 8 Export Manager
EMEA
Joachim Kabisch |
| | 9 Export Manager
Asia-Pacific
Marco Bisconti |
| | 10 Export Manager
Americas
Basil Ott |



5



6



7



8



9



10

11 Sales Switzerland
Order Processing/
Technical Consulting
Test Fixtures
Gerd Graninger

12 Head of Order
Processing/Technical
Consulting Test Fixtures
Thomas Haidle

13 Order Processing/
Technical Consulting Test
Fixtures with customizing
Erhard Mayer

14 Order Processing/
Technical Consulting
Test Fixtures with
customizing
Hans Rohn

15 Order Processing/
Technical Consulting
Test Fixtures with
customizing
Martina Bruttel

16 Order Processing/
Technical Consulting
Test Fixtures with
customizing
Moritz Witt

17 Order Processing/
Technical Consulting
Test Fixtures with
customizing
Christoph Sehle

18 Order Processing/
Technical Consulting
Test Fixtures with
customizing
Juri Neigum

19 Order Processing/
Technical Consulting
Test Fixtures Basic Units
and Accessories
Stefan Fischer



11



12



13



14



15



16



17



18



19

Standard Test Fixtures

Manual, Pneumatic and Vacuum-operated Test Fixtures for all common Test Systems and Interfaces
from page 7 to page 55.

Technical changes possible without prior notification.

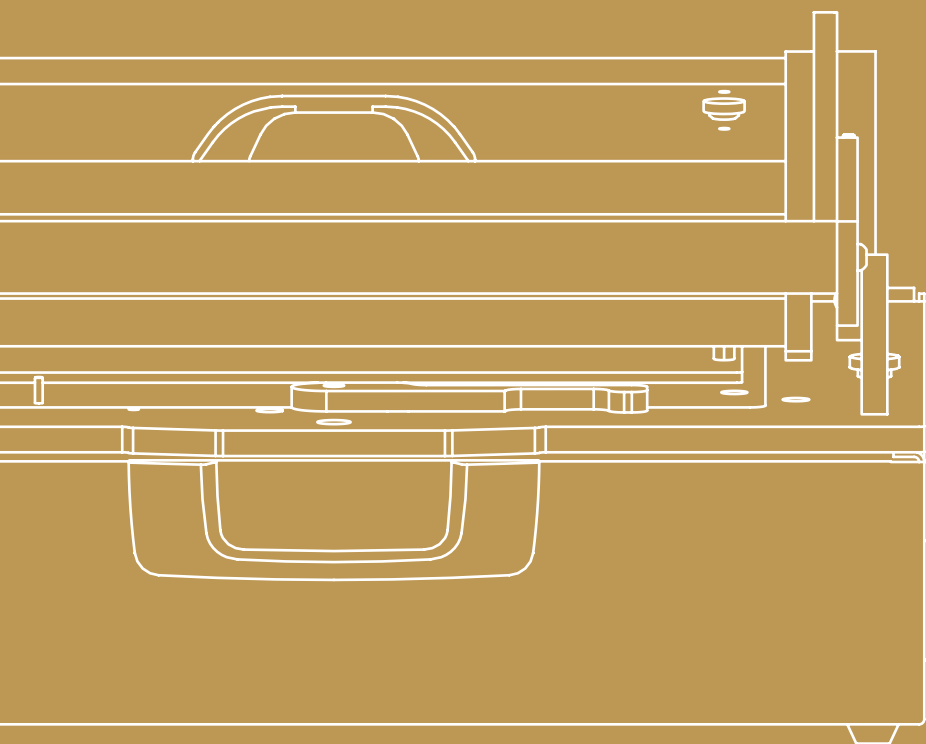

Manual Test Fixtures	MA 160	Page	8
	MA 2109	Page	9
	MA 2111	Page	10
	MA 2112	Page	11
	MA 2113	Page	13
	MA 2113T	Page	15
	MA 2114	Page	16
	MA 21xx-2	Page	17
	MA 21xx-Start-up Kits	Page	18
	MA 21xx-Interchangeability made easy	Page	19
	MA 21xx-Matrix	Page	20
	ATS 21xx-Matrix	Page	22
	MA 21xx/ATS 21xx-Additional Components	Page	24
	MA 21xx-Test Fixture customizing	Page	27
Pneumatic Test Fixtures	PAZ 100, PAZ 200, PAZ 200-2	Page	29
	PAZ 215, PA 2130	Page	30
	PAZ-Test Fixture customizing	Page	31
Vacuum Test Fixtures	VA 2030, VA 2040, VA2130, VA 2140, VIN 423, VIN 2040	Page	34
	Test Fixtures for the following Test Systems: Aeroflex P. 35, Digitaltest P. 36, Agilent Technologies P. 38 Reinhardt P. 41, Rhode&Schwarz P. 42, Spea P. 43, Teradyne P. 44, Teststation GR P. 46, Dr. Eschke Elektronik P. 47, VPC P. 48	Page	35–48
	Vacuum Interchangeable Test Fixture VIN 2040	Page	49
	Rigid-pin Test Fixtures	Page	51
	Vacuum-sealed Covers	Page	52
	Customizing with Vacuum-free zone	Page	53
	Additional Contacting Unit ZSK 320/420	Page	54
Additional Contacting Unit ZSK 2030/2040/2070/2171/2800	Page	55	

Mechanical Test Fixtures

The contacting stroke of the Mechanical Fixtures from INGUN is generated either by manual activation, by a pneumatic drive or by means of vacuum.

The Manual and Pneumatic Fixtures from INGUN are generally designed as interchangeable Fixtures. The series vary in regard to contacting force, usable area and drive/activation mechanics. When contacted, the drive unit can be hinged open together with the PC-Board (exception: MA 160).

INGUN offers a large range of Intermediate Interfaces for the Interchangeable Fixtures. Intermediate Interfaces can be modularly loaded with different Interface-Blocks (see page 58).

In regard to the mechanics, INGUN differentiates in regard to the following standard series:

Manual Activation:

- MA 160
- MA 2109/2111/2112/2113/2113 T/2114
- MA 2112-2/MA 2113-2

Pneumatic Activation:

- PA 2130
- PAZ 200/215

Vacuum Activation:

- VA xxxx/xxxx-2
- VIN xxxx/xxxx-2
- VSN xxx

The Manual and Pneumatic Fixtures from INGUN are designed modularly.

Basic Unit consisting of:

- Drive Unit
(including Assembly Plate with Interface Mounting)
- Housing

Fixture Customizing Materials, i.e.:

- Tooling Pins (FS)
- Support Disks (VA-PVC)
- Pushrods (NDH)
- Pre-registration Pins

Replacement Kit (ATS) consisting of:

- PVC Pressure Frame Plate (NDH-WPL), anti-static, transparent
- Spring-loaded Mounting Plate, ESD suitable
- Probe Plate (KTP)
- Wiring Guard (KTC)

Project-specific Accessories, among other consisting of:

- Stroke Counter
- Poti screwing Unit
- Key/button Activation
- Marking Units



Basic Unit and Replacement Kit



Project-specific Accessories



Customizing Accessories

Manual Test Fixtures

MA 160

The Manual Test Fixture MA 160 is designed for usage in labs and for small batches. The contacting force is created by the operator by pushing down the Pressure Frame, which locks in the contacting position.

Basic Units

Part No. 33670	MA 160 Basic Unit	Outside Dimensions: 288 × 183 × 158 mm (w × d × h) Contact Force: max. 100 N
-----------------------	----------------------	---

Replacement Kits

Part No. 28385	ATS 160 Standard Replacement Kit	Usable Area: 160 × 100 mm (w × d)
Part No. 30800	ATS 160/ESD ESD Replacement Kit	Usable Area: 160 × 100 mm (w × d)

MA 160-Start-up Kit

INGUN offers the MA 160 Start-up Kit for self-customizing of the Manual Test Fixture MA 160. This Start-up Kit contains all the commonly used customizing materials.

	Amount in pieces	Description
Part No. 29070	10	Cap for Pushrod Ø 2.5 mm
	10	Lens head Screw M3x10
	10	Washer DIN 9021-3.4
	4	Pre-registration Pin Ø 10 mm
	4	Countersunk Screw with Allen screw recess M4x10
	10	PCB Support Disk Ø 5.0 mm
	2	Tooling Pin Ø 2.9 mm
	2	Tooling Pin Ø 4.0 mm
	50	Receptacle KS-100 30 05 (Solder Connection)
	25	Spring-loaded Test Probe GKS-100 291 090 A 2000 (Dagger)
	25	Spring-loaded Test Probe GKS-100 214 150 A 2000 (Crown)

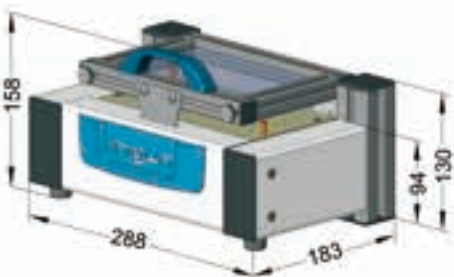

Detailed dimensional drawing of:
MA 160 with ATS 160



MA 160 with ATS 160



MA 160 and ATS 160

MA 21xx

The Manual Test Fixture series MA 21xx excels itself with high contacting force, modular Intermediate Interface and excellent ergonomics. With up to 2.000 N contacting force, when assembled with stiffener bars, the Manual Test Fixtures achieve forces that until now have only been known by Vacuum Fixtures.

The Intermediate Interface can be configured with INGUN Interface Blocks modularly. The Replacement Kits which are locked and unlocked from the front side, are exchangeable with only a few hand movements and even without the need of any tools. The Pressure Frame Plate can also be changed within seconds by means of the patented locking bar. For storage purposes the Pressure Frame Plate and the Probe Plate Unit can be connected together as a stackable unit.

Special Features:

- High Contacting Force up to 2.000 N
- Quick-exchange system, without post adjustment
- Low-ohm and modular Intermediate Interface for INGUN Interface Blocks
- Convenient placement of the PC-Board due to the larger opening angle of the Pressure Frame (approx. 70°)
- Energy-saving opening mechanism with self-opening Pressure Frame (from an angle of 50° on) with end-stroke cushioned gas pressure springs on the inner side

The basic units have been strengthened to allow usage of an Intermediate Interface. Replacement Kits are available with or without an Intermediate Interface Frame.

MA 2109

Basic Units

Part No. 34340	MA 2109/D/H/S-5 Basic Unit	Outside Dimensions: 320 × 445 × 270 mm (w × d × h) Contact Force: max. 2.000 N Interface Blocks: max. 5
-----------------------	-------------------------------	---

Replacement Kits

Part No. 34140-KIT (34140)*	ATS 2109/S-5 Standard Replacement Kit with Intermediate Interface Frame	Usable Area: 150 × 170 mm (w × d) Interface Blocks: max. 5
Part No. 34270-KIT (34270)*	ATS 2009 Standard Replacement Kit without Intermediate Interface Frame	Usable Area: 150 × 170 mm (w × d) Interface Blocks: 0
Part No. 38830-KIT (38830)*	ATS 2109/S-5/ESD ESD-Replacement Kit with Intermediate Interface Frame	Usable Area: 150 × 170 mm (w × d) Interface Blocks: max. 5
Part No. 37645-KIT (37645)*	ATS 2009/ESD ESD-Replacement Kit without Intermediate Interface Frame	Usable Area: 150 × 170 mm (w × d) Interface Blocks: 0
Part No. 39318-KIT (39318)*	ATS 2109/S-5/FR4 FR4-Replacement Kit with Intermediate Interface Frame	Usable Area: 150 × 170 mm (w × d) Interface Blocks: max. 5
Part No. 39443-KIT (39443)*	ATS 2009/FR4 FR4-Replacement Kit without Intermediate Interface Frame	Usable Area: 150 × 170 mm (w × d) Interface Blocks: 0

* Part No. XXXXX-KIT = ATS is delivered completely demounted (standard delivery condition)
Part No. XXXXX = ATS is delivered completely mounted

Spare Part Kits see page 18.

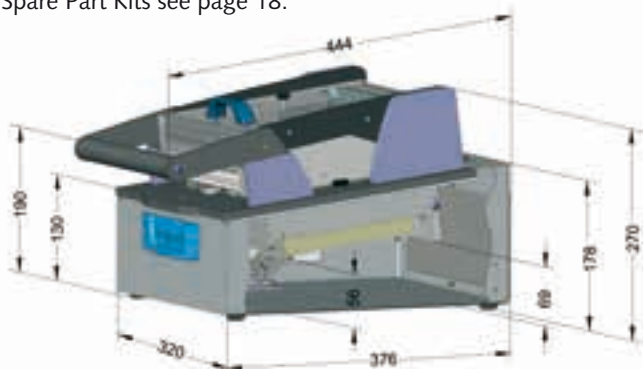

Detailed dimensional drawing of:
MA 2109/D/H/S-5 with ATS 2109/S-5



MA 2109/D/H/S-5 with ATS 2109/S-5

MA 2111

Basic Units

Part No. 31730	MA 2111/D/H/S-5 Basic Unit	Outside Dimensions: 320 × 515 × 270 mm (w × d × h) Contact Force: max. 2.000 N Interface Blocks: max. 5
Part No. 32650	MA 2111/D/H/S-5/LI Basic Unit with Drive Unit MA 2111 left mounted on housing MA 2113	Outside Dimensions: 620 × 520 × 275 mm (w × d × h) Contact Force: max. 2.000 N Interface Blocks: max. 5
Part No. 32651	MA 2111/D/H/S-5/RE Basic Unit with Drive Unit MA 2111 right mounted on housing MA 2113	Outside Dimensions: 620 × 520 × 275 mm (w × d × h) Contact Force: max. 2.000 N Interface Blocks: max. 5
Part No. 33420	MA 2111/D/H/S-5/HG Basic Unit with tall housing	Outside Dimensions: 320 × 515 × 370 mm (w × d × h) Contact Force: max. 2.000 N Interface Blocks: max. 5

Replacement Kits

Part No. 32450-KIT (32450)*	ATS 2111/S-5 Standard Replacement Kit with Intermediate Interface Frame	Usable Area: 150 × 240 mm (w × d) Interface Blocks: max. 5
Part No. 31750-KIT (31750)*	ATS 2011 Standard Replacement Kit without Intermediate Interface Frame	Usable Area: 150 × 240 mm (w × d) Interface Blocks: 0
Part No. 38832-KIT (38832)*	ATS 2111/S-5/ESD ESD Replacement Kit with Intermediate Interface Frame	Usable Area: 150 × 240 mm (w × d) Interface Blocks: max. 5
Part No. 37641-KIT (37641)*	ATS 2011/ESD ESD Replacement Kit without Intermediate Interface Frame	Usable Area: 150 × 240 mm (w × d) Interface Blocks: 0
Part No. 38573-KIT (38573)*	ATS 2111/S-5/FR4 FR4 Replacement Kit with Intermediate Interface Frame	Usable Area: 150 × 240 mm (w × d) Interface Blocks: max. 5
Part No. 39441-KIT (39441)*	ATS 2011/FR4 FR4 Replacement Kit without Intermediate Interface Frame	Usable Area: 150 × 240 mm (w × d) Interface Blocks: 0
Part No. 44412	ATS 2111/S-5/HF RF Replacement Kit with Intermediate Interface Frame	Usable Area: 100 × 160 mm (w × d) Interface Blocks: max. 5
Part No. 44411	ATS 2011/HF RF Replacement Kit without Intermediate Interface Frame	Usable Area: 100 × 160 mm (w × d) Interface Blocks: 0

* Part No. XXXXX-KIT = ATS is delivered completely demounted (standard delivery condition)
Part No. XXXXX = ATS is delivered completely mounted

Spare Part Kits see page 18.

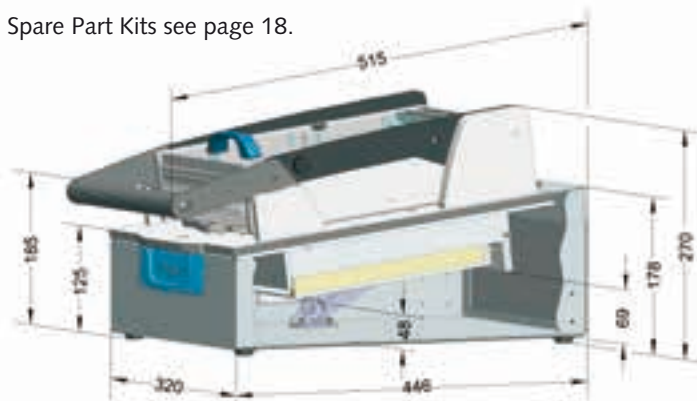

Detailed dimensional drawing of:
MA 2111/D/H/S-5 with ATS 2111/S-5



MA 2111/D/H/S-5 with ATS 2111/S-5

MA 2112

Basic Units

Part No. 32660	MA 2112/D/H/S-7 Basic Unit	Outside Dimensions: 460 × 515 × 270 mm (w × d × h) Contact Force: max. 2.000 N Interface Blocks: max. 7
Part No. 33460	MA 2112/D/H/S-7/HG Basic Unit with tall housing	Outside Dimensions: 460 × 515 × 370 mm (w × d × h) Contact Force: max. 2.000 N Interface Blocks: max. 7

Replacement Kits

Part No. 32340-KIT (32340)*	ATS 2112/S-7 Standard Replacement Kit with Intermediate Interface Frame	Usable Area: 285 × 240 mm (w × d) Interface Blocks: max. 7
Part No. 32330-KIT (32330)*	ATS 2012 Standard Replacement Kit without Intermediate Interface Frame	Usable Area: 285 × 240 mm (w × d) Interface Blocks: 0
Part No. 34850-KIT (34850)*	ATS 2112/S-7/ESD ESD Replacement Kit with Intermediate Interface Frame	Usable Area: 285 × 240 mm (w × d) Interface Blocks: max. 7
Part No. 34495-KIT (34495)*	ATS 2012/ESD ESD Replacement Kit without Intermediate Interface Frame	Usable Area: 285 × 240 mm (w × d) Interface Blocks: 0
Part No. 39316-KIT (39316)*	ATS 2112/S-7/FR4 FR4 Replacement Kit with Intermediate Interface Frame	Usable Area: 285 × 240 mm (w × d) Interface Blocks: max. 7
Part No. 39440-KIT (39440)*	ATS 2012/FR4 FR4 Replacement Kit without Intermediate Interface Frame	Usable Area: 285 × 240 mm (w × d) Interface Blocks: 0
Part No. 33335	ATS 2112/S-7/SN Rigid-Pin Replacement Kit with Intermediate Interface Frame	Usable Area: 255 × 220 mm (w × d) Interface Blocks: max. 7
Part No. 44414	ATS 2112/S-7/HF RF Replacement Kit with Intermediate Interface Frame	Usable Area: 215 × 180 mm (w × d) Interface Blocks: max. 7
Part No. 44413	ATS 2012/HF RF Replacement Kit without Intermediate Interface Frame	Usable Area: 215 × 180 mm (w × d) Interface Blocks: 0

* Part No. XXXXX-KIT = ATS is delivered completely demounted (standard delivery condition)
Part No. XXXXX = ATS is delivered completely mounted

Spare Part Kits see page 18.

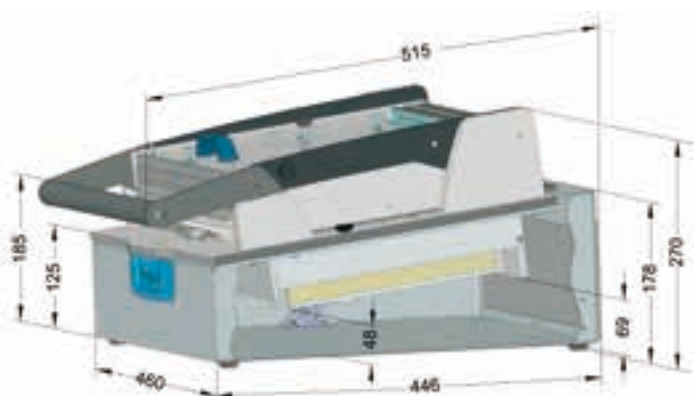

Detailed dimensional drawing of:
MA 2112/D/H/S-7 with ATS 2112/S-7



MA 2112/D/H/S-7 with ATS 2112/S-7

MA 2112 with In-Circuit-Test System Interfaces

The high contacting force of up to 2.000 N allows the combination of Manual Test Fixtures with all common In-circuit Test Systems.

Basic Units

Part No. 33750	MA 2112/F/H/S-7/Aeroflex 4200/4250	Outside Dimensions: 485 × 560 × 275 mm (w × d × h)
Part No. 33045	MA 2112/D/H/S-7/MTS 100	Outside Dimensions: 540 × 515 × 270 mm (w × d × h)
Part No. 32958	MA 2112/D/H/S-7/MTS 300	Outside Dimensions: 575 × 580 × 255 mm (w × d × h)
Part No. 40978	MA 2112/D/H/S-7/MAC-Panel Titan Hz	Outside Dimensions: 460 × 520 × 265 mm (w × d × h)
Part No. 32735	MA 2112/D/H/S-7/Reinhardt VG12	Outside Dimensions: 550 × 580 × 260 mm (w × d × h)
Part No. 37970	MA 2112/S-7/Spa 3030 (without housing – for mounting on Test System)	Outside Dimensions: 460 × 545 × 110 mm (w × d × h)
Part No. 32965	MA 2112/F/H/S-7/TD 88xx-S	Outside Dimensions: 620 × 585 × 255 mm (w × d × h)
Part No. 33464	MA 2112/F/H/S-7/TD 88xx-M	Outside Dimensions: 620 × 585 × 255 mm (w × d × h)
Part No. 44880	MA 2112/D/H/S-7/GR 228x 15/07	Outside Dimensions: 550 × 525 × 335 mm (w × d × h)
Part No. 37745	MA 2112/D/H/S-7/GR 228x 15/15	Outside Dimensions: 550 × 525 × 335 mm (w × d × h)
Part No. 33462	MA 2112/D/H/S-7/GR 2270/71	Outside Dimensions: 485 × 550 × 265 mm (w × d × h)
Part No. 33681	MA 2112/D/H/S-7/Pylon 9.6	Outside Dimensions: 485 × 550 × 265 mm (w × d × h)
Part No. 33040	MA 2112/D/H/S-7/VPC-S6	Outside Dimensions: 460 × 500 × 265 mm (w × d × h)
Part No. 35503	MA 2112/D/H/S-7/VPC-G12-12	Outside Dimensions: 460 × 560 × 265 mm (w × d × h)
Part No. 33480	MA 2112/D/H/S-7/HG/KT-ITA-21	Outside Dimensions: 460 × 545 × 365 mm (w × d × h)
Part No. 33457	MA 2112/D/H/S-7/HG/GR 2270/71	Outside Dimensions: 485 × 550 × 365 mm (w × d × h)
Part No. 33678	MA 2112/D/H/S-7/HG/Pylon 9.6	Outside Dimensions: 485 × 550 × 365 mm (w × d × h)

Further variants available on request. Replacement Kits see page 11.

Spare Part Kits see page 18.



MA 2112/D/H/S-7/GR 228x 15/15



MA 2112/D/H/S-7/Pylon 9.6

MA 2113

Basic Units

Part No. 32500	MA 2113/D/H/S-10 Basic Unit	Outside Dimensions: 620 × 585 × 270 mm (w × d × h) Contact Force: max. 2.000 N Interface Blocks: max. 10
Part No. 32700	MA 2113/D/H/S-10/HG Basic Unit with tall housing	Outside Dimensions: 620 × 585 × 370 mm (w × d × h) Contact Force: max. 2.000 N Interface Blocks: max. 10

Replacement Kits

Part No. 31440-KIT (31440)*	ATS 2113/S-10 Standard Replacement Kit with Intermediate Interface Frame	Usable Area: 455 × 310 mm (w × d) Interface Blocks: max. 10
Part No. 32605-KIT (32605)*	ATS 2013 Standard Replacement Kit without Intermediate Interface Frame	Usable Area: 455 × 310 mm (w × d) Interface Blocks: 0
Part No. 38835-KIT (38835)*	ATS 2113/S-10/ESD ESD Replacement Kit with Intermediate Interface Frame	Usable Area: 455 × 310 mm (w × d) Interface Blocks: max. 10
Part No. 38667-KIT (38667)*	ATS 2013/ESD ESD Replacement Kit without Intermediate Interface Frame	Usable Area: 455 × 310 mm (w × d) Interface Blocks: 0
Part No. 39320-KIT (39320)*	ATS 2113/S-10/FR4 FR4 Replacement Kit with Intermediate Interface Frame	Usable Area: 455 × 310 mm (w × d) Interface Blocks: max. 10
Part No. 39437-KIT (39437)*	ATS 2013/FR4 FR4 Replacement Kit without Intermediate Interface Frame	Usable Area: 455 × 310 mm (w × d) Interface Blocks: 0
Part No. 44416	ATS 2113/S-10/HF RF Replacement Kit with intermediate Interface Frame	Usable Area: 370 × 250 mm (w × d) Interface Blocks: max. 10
Part No. 44415	ATS 2013/HF RF Replacement Kit without intermediate Interface Frame	Usable Area: 370 × 250 mm (w × d) Interface Blocks: 0

* Part No. XXXXX-KIT = ATS is delivered completely demounted (standard delivery condition)
Part No. XXXXX = ATS is delivered completely mounted

Spare Part Kits see page 18.

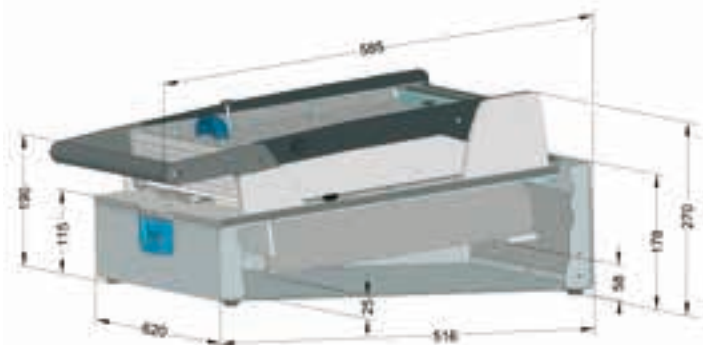

Detailed dimensional drawing of:
MA 2113/D/H/S-10 with ATS 2113/S-10

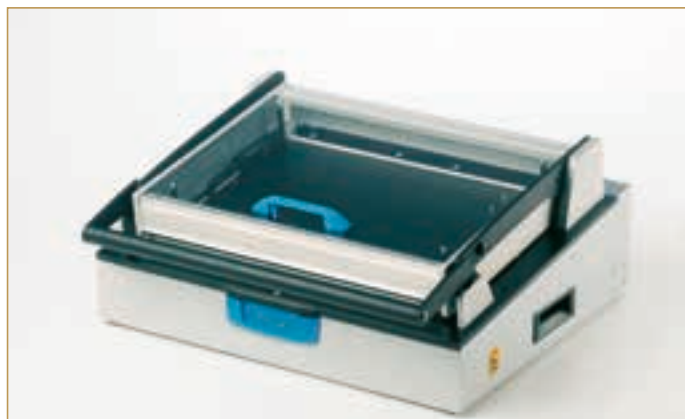

MA 2113/D/H/S-10 with ATS 2113/S-10

MA 2113 with In-Circuit-Test System Interfaces

The high contacting force of up to 2.000 N allows the combination of Manual Test Fixtures with all common In-circuit Test Systems.

Basic Units

Part No. 37736	MA 2113/F/H/S-10/Aeroflex 4200/4250	Outside Dimensions: 620 × 600 × 300 mm (w × d × h)
Part No. 42600	MA 2113/D/H/S-10/Agilent i 1000	Outside Dimensions: 620 × 585 × 270 mm (w × d × h)
Part No. 33443	MA 2113/D/H/S-10/MTS 300	Outside Dimensions: 620 × 585 × 265 mm (w × d × h)
Part No. 38871	MA 2113/D/H/S-10/Reinhardt VG12	Outside Dimensions: 620 × 655 × 280 mm (w × d × h)
Part No. 32701	MA 2113/S-10/Spica 3030 (without housing – for mounting on Test System)	Outside Dimensions: 620 × 615 × 110 mm (w × d × h)
Part No. 33290	MA 2113/D/H/S-10/TD 88xx-S	Outside Dimensions: 620 × 585 × 265 mm (w × d × h)
Part No. 33444	MA 2113/D/H/S-10/TD 88xx-M	Outside Dimensions: 620 × 585 × 265 mm (w × d × h)
Part No. 33764	MA 2113/D/H/S-10/GR 228x 15/07	Outside Dimensions: 620 × 585 × 335 mm (w × d × h)
Part No. 32920	MA 2113/D/H/S-10/GR 2270/71	Outside Dimensions: 635 × 620 × 265 mm (w × d × h)
Part No. 33688	MA 2113/D/H/S-10/Pylon 9.6	Outside Dimensions: 620 × 620 × 265 mm (w × d × h)
Part No. 35904	MA 2113/D/H/S-10/VPC-G12-12	Outside Dimensions: 620 × 635 × 265 mm (w × d × h)
Part No. 37799	MA 2113/D/H/S-10/VPC-G12-18	Outside Dimensions: 620 × 620 × 270 mm (w × d × h)
Part No. 33448	MA 2113/D/H/S-10/HG/GR 2270/71	Outside Dimensions: 620 × 620 × 365 mm (w × d × h)
Part No. 33679	MA 2113/D/H/S-10/HG/Pylon 9.6	Outside Dimensions: 635 × 620 × 365 mm (w × d × h)

Further variants available on request. Replacement Kits see page 13.
Spare Part Kits see page 18.



MA 2113/D/H/S-10/TD 88xx-S



MA 2113/D/H/S-10/VPC-G12-12

MA 2113 T

Basic Units

Part No. 32300	MA 2113T/D/H/2x S-5 Basic Unit	Outside Dimensions: 620 × 530 × 270 mm (w × d × h) Contact Force: max. 2.000 N Interface Blocks: max. 10
Part No. 36666	MA 2113T/D/H/2x S-5/HG Basic Unit with tall Housing	Outside Dimensions: 620 × 530 × 370 mm (w × d × h) Contact Force: max. 2.000 N Interface Blocks: max. 10

Replacement Kits

Part No. 32450-KIT (32450)*	ATS 2111/S-5 Standard Replacement Kit with Intermediate Interface Frame	Usable Area: 150 × 240 mm (w × d) Interface Blocks: max. 5
Part No. 31750-KIT (31750)*	ATS 2011 Standard Replacement Kit without Intermediate Interface Frame	Usable Area: 150 × 240 mm (w × d) Interface Blocks: 0
Part No. 38832-KIT (38832)*	ATS 2111/S-5/ESD ESD Replacement Kit with Intermediate Interface Frame	Usable Area: 150 × 240 mm (w × d) Interface Blocks: max. 5
Part No. 37641-KIT (37641)*	ATS 2011/ESD ESD Replacement Kit without Intermediate Interface Frame	Usable Area: 150 × 240 mm (w × d) Interface Blocks: 0
Part No. 38573-KIT (38573)*	ATS 2111/S-5/FR4 FR4 Replacement Kit with Intermediate Interface Frame	Usable Area: 150 × 240 mm (w × d) Interface Blocks: max. 5
Part No. 39441-KIT (39441)*	ATS 2011/FR4 FR4 Replacement Kit without Intermediate Interface Frame	Usable Area: 150 × 240 mm (w × d) Interface Blocks: 0
Part No. 44412	ATS 2111/S-5/HF RF Replacement Kit with Intermediate Interface Frame	Usable Area: 100 × 160 mm (w × d) Interface Blocks: max. 5
Part No. 44411	ATS 2011/HF RF Replacement Kit without Intermediate Interface Frame	Usable Area: 100 × 160 mm (w × d) Interface Blocks: 0

* Part No. XXXXX-KIT = ATS is delivered completely demounted (standard delivery condition)
Part No. XXXXX = ATS is delivered completely mounted

For dual-chamber (tandem) customizing of MA 2113T two Replacement Kits ATS 2111 are necessary.
Spare Part Kits see page 18.

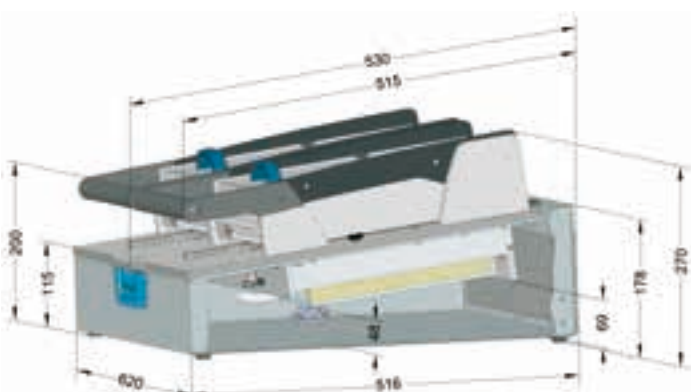

Detailed dimensional drawing of:
MA 2113T/D/H/2x S-5 mit 2x ATS 2111/S-5



MA 2113T/D/H/2x S-5 mit 2x ATS 2111/S-5

MA 2113T with In-Circuit-Test System Interfaces

The high contacting force of up to 2.000 N allows the combination of Manual Test Fixtures with all common In-circuit Test Systems.

Basic Units

Part No. 33380	MA 2113T/D/H/2x S-5/MTS 300	Outside Dimensions: 620 × 530 × 265 mm (w × d × h)
Part No. 33439	MA 2113T/D/H/2x S-5/TD 88xx-S	Outside Dimensions: 620 × 530 × 265 mm (w × d × h)
Part No. 33440	MA 2113T/D/H/2x S-5/TD 88xx-M	Outside Dimensions: 620 × 530 × 265 mm (w × d × h)
Part No. 44630	MA 2113T/D/H/2x S-5/GR 228x 15/07	Outside Dimensions: 620 × 515 × 335 mm (w × d × h)
Part No. 33543	MA 2113T/D/H/2x S-5/GR 2270/71	Outside Dimensions: 620 × 515 × 265 mm (w × d × h)
Part No. 33680	MA 2113T/D/H/2x S-5/Pylon 9.6	Outside Dimensions: 620 × 515 × 265 mm (w × d × h)

Further variants available on request. Replacement Kits see page 15.

MA 2114

Basic Units

Part No. 34350	MA 2114/D/H/S-10 Basic Unit	Outside Dimensions: 720 × 585 × 270 mm (w × d × h) Contact Force: max. 2.000 N Interface Blocks: max. 10
-----------------------	--------------------------------	--

Replacement Kits

Part No. 34490-KIT (34490)*	ATS 2114/S-10 Standard Replacement Kit with Intermediate Interface Frame	Usable Area: 540 × 310 mm (w × d) Interface Blocks: max. 10
Part No. 34345-KIT (34345)*	ATS 2014 Standard Replacement Kit without Intermediate Interface Frame	Usable Area: 540 × 310 mm (w × d) Interface Blocks: 0
Part No. 38931-KIT (38931)*	ATS 2114/S-10/ESD ESD Replacement Kit with Intermediate Interface Frame	Usable Area: 540 × 310 mm (w × d) Interface Blocks: max. 10
Part No. 38930-KIT (38930)*	ATS 2014/ESD ESD Replacement Kit without Intermediate Interface Frame	Usable Area: 540 × 310 mm (w × d) Interface Blocks: 0
Part No. 39319-KIT (39319)*	ATS 2114/S-10/FR4 FR4 Replacement Kit with Intermediate Interface Frame	Usable Area: 540 × 310 mm (w × d) Interface Blocks: max. 10
Part No. 39435-KIT (39435)*	ATS 2014/FR4 FR4 Replacement Kit without Intermediate Interface Frame	Usable Area: 540 × 310 mm (w × d) Interface Blocks: 0

* Part No. XXXXX-KIT = ATS is delivered completely demounted (standard delivery condition)
Part No. XXXXX = ATS is delivered completely mounted

Spare Part Kits see page 18.

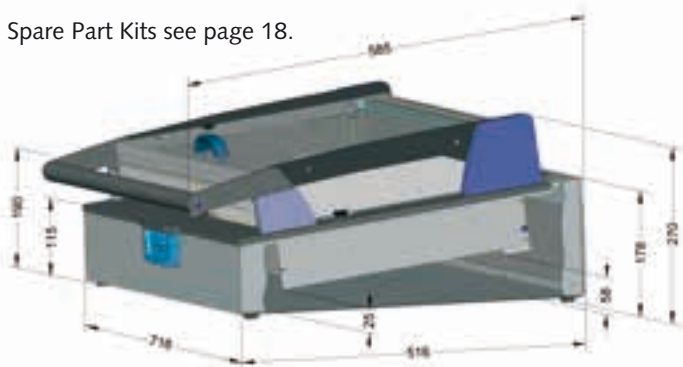

Detailed dimensional drawing of:
MA 2114/D/H/S-10 mit ATS 2114/S-10



MA 2114/D/H/S-10 mit ATS 2114/S-10

MA 21xx (dual-stage versions)

Dual-stage solutions for combined In-circuit- (ICT) and Functional Test (FCT) in two different versions.

1.) Dual-stage option with electromagnetic stroke limitation

For Manual Test Fixtures MA 21xx dual-stage options with electromagnetic stroke limitation are available as an upgrade kit. The combined stroke is realized **manually**. The first contacting stage for ICT is reached as soon as the Pressure Frame Unit is completely closed. The second contacting stage for FCT, that lies above the first

contacting stage, is reached by lifting up the handle. The limitation of both contacting stages is realized electromagnetically by means of two stroke magnets. The Replacement Kit which is required is the standard ATS 21xx (see page 11 and 13) with a dual-stage assembly.

Part No. 43613 Electromagnetic dual-stage stroke limitation for MA 2111 / MA 2112 and MA 2113T

Part No. 43642 Electromagnetic dual-stage stroke limitation for MA 2113 and MA 2114

2.) Dual-stage Retrofit Kits for Standard Basic Units MA 21xx

The single-stage Standard Test Fixtures MA 2112 and MA 2113 can be easily and quickly upgraded to dual-stage Test Fixtures. To do this dual-stage Retrofit Kits and dual-stage Replacement Kits are available. The combined stroke is generated **pneumatically**. The first contacting stage for ICT is reached as soon as the Pressure Frame

Unit is completely closed. The second contacting stage for FCT, that lies above the first contacting stage, is reached by lifting up of the Pressure Frame Plate by means of four pneumatically operated lifting cylinders with return springs. The dual-stage Retrofit Kit is only required once. This version is delivered without magnet valve.

Part No. 34660 Dual-stage Retrofit Kit MA 2112

Contact Force: max. 1.200 N

Part No. 38790 Dual-stage Retrofit Kit MA 2113

Contact Force: max. 1.200 N

Part No. 34820-KIT ATS 2112-2/S-7
(34820)* Dual-stage Replacement Kit

Usable Area: 230 × 215 mm (w × d)

Interface Blocks: max. 7

Part No. 39055-KIT ATS 2113-2/S-10
(39055)* Dual-stage Replacement Kit

Usable Area: 390 × 285 mm (w × d)

Interface Blocks: max. 10

* Part No. XXXXX-KIT = ATS is delivered completely demounted (standard delivery condition)
Part No. XXXXX = ATS is delivered completely mounted



MA 2112/D/H/S-7 with electromagnetic dual-stage stroke limitation



Dual-stage Retrofit Kit MA 2112

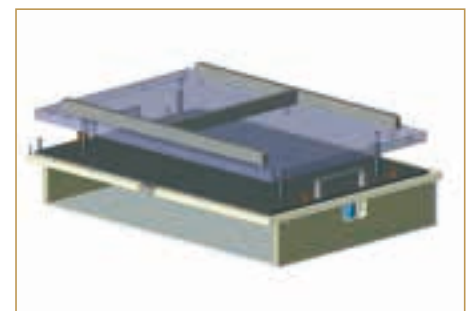

ATS 2113-2/S-10

MA 21xx - Start-up Kits

INGUN offers the MA 21xx Start-up Kits for self-customizing of the Manual Test Fixtures MA 21xx. These Start-up Kits contain all the commonly used customizing materials.

Start-up Kits MA 21xx (amount in pieces)

Small Part No. 34730	Medium Part No. 34731	Large Part No. 34732	Description
5	10	15	Pushrod Ø 6.0 mm
10	20	30	Pushrod Ø 2.5 mm
3	3	3	Pre-registration Pin Ø 12 mm
3	3	3	Cross-head Screw Pin M4x12
15	30	45	PCB Support Disk Ø 5.0 mm (anti-static)
2	2	2	Tooling Pin Ø 4 mm
100	200	300	Receptacle KS-100 47 05 (Wire-Wrap-Post)
100	200	300	Spring loaded Test Probe GKS-100 291 130 A 2000 (Dagger)

Spare Part Kits Gas Pressure Springs

Part No. 41150	Spare Part Kit Gas Pressure Springs for MA 2109 with 150 N
Part No. 39200	Spare Part Kit Gas Pressure Springs for MA 2111/12 with 200 N
Part No. 39400	Spare Part Kit Gas Pressure Springs for MA 2113 with 400 N
Part No. 39500	Spare Part Kit Gas Pressure Springs for MA 2114 with 500 N

Spare Part Kits Contact Springs

Part No. 41766	Spare Part Kit Contact Springs for RF Replacement Kit ATS 2x11/(S-5)/HF	(suitable for Part No. 44411 and 44412)
Part No. 41765	Spare Part Kit Contact Springs for RF Replacement Kit ATS 2x12/(S-7)/HF	(suitable for Part No. 44413 and 44414)
Part No. 42410	Spare Part Kit Contact Springs for RF Replacement Kit ATS 2x13/(S-10)/HF	(suitable for Part No. 44415 and 44416)

Replacement Kits for Manual Test Fixtures MA 130, MA 135, MA 2110, MA 2130 and MA 2135

Replacement Kits for manual Test Fixtures MA 130, MA 135, MA 2110, MA 2130 and MA 2135 are still available.

Replacement Kits

Part No. 17640	KTE 130/KTE 2130 Standard Replacement Kit for MA 130 / MA 2130	Usable Area: 240 × 220 mm (w × d)
Part No. 17638	KTE 135/KTE 2135 Standard Replacement Kit for MA 135 / MA 2135	Usable Area: 355 × 270 mm (w × d)
Part No. 19026	ATS 2110 Standard Replacement Kit for MA 2110	Usable Area: 270 × 190 mm (w × d)



Start-up Kit MA 21xx - Small



Probe Plate Unit KTE 135/KTE 2135

MA 21xx/ATS 21xx – Interchangeability made easy

MA 21xx upgrade for new testing demands



1.) Lift up the handle upwards and open Pressure Frame Unit completely



2.) Unlock the Probe Plate Unit at the front by means of the hand lever, lift upwards and take it out of the mounting

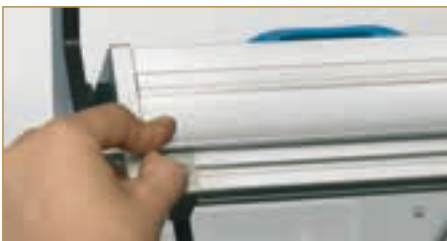

3.) Move Safety-pusher to the left, press locking bar and take out Pressure Frame Plate from above





4.) Move Safety-pusher to the left, press locking bar and put in Pressure Frame Plate latching from above



5.) Slide Probe Plate Unit into the mounting, lock at the front by means of the hand lever and close Pressure Frame Unit



































MA 21xx-Matrix

 Test System Interfaces Basic Units	 Aeroflex 4200/4250	 i1000	 MTS 100	 MTS 300	 KT-ITA-21	 TITAN Hz	 VG12
	AEROFLEX	AGILENT	DIGITALTEST		KONRAD	MAC-PANEL	REINHARDT
 MA 2109 MA 2109/D/H/S-5 Part 34340							
 MA 2111 MA 2111/D/H/S-5 Part 31730							
 MA 2111/HG MA 2111/D/H/S-5/HG Part 33420							
 MA 2112 MA 2112/D/H/S-7 Part 32660	Part 33750  .../F/H/S-7/...		Part 33045  .../D/H/S-7/...	Part 32958  .../D/H/S-7/...		Part 40978  .../D/H/S-7/...	Part 32735  .../D/H/S-7/...
 MA 2112/HG MA 2112/D/H/S-7/HG Part 33460					Part 33480  .../D/H/S-7/...		
 MA 2113 MA 2113/D/H/S-10 Part 32500	Part 37736  .../F/H/S-10/...	Part 42600  .../D/H/S-10/...		Part 33443  .../D/H/S-10/...			Part 38871  .../D/H/S-10/...
 MA 2113/HG MA 2113/D/H/S-10/HG Part 32700							
 MA 2113 T MA 2113T/D/H/2x S-5 Part 32300				Part 33380  .../D/H/2x S-5/...			
 MA 2113 T/HG MA 2113T/D/H/2x S-5/HG Part 36666							
 MA 2114 MA 2114/D/H/S-10 Part 34350							

 Spea 3030	 TD 88xx-S	 TD 88xx-M	 GR 228x 15/07	 GR 228x 15/15	 GR 2270/71	 Pylon 9,6	 VPC-S6	 VPC-G12-12	 VPC-G12-18
SPEA	TERADYNE		TESTSTATION GR			DR. ESCHKE, GEDIS, ROHDE&SCHWARZ	GEDIS, ROHDE&SCHWARZ VPC VIRGINIA PANEL		
Part 37970  .../S-7/... (ohne Gehäuse)	Part 32965  .../F/H/S-7/...	Part 33464  .../F/H/S-7/...	Part 44880  .../D/H/S-7/...	Part 37745  .../D/H/S-7/...	Part 33462  .../D/H/S-7/...	Part 33681  .../D/H/S-7/...	Part 33040  .../D/H/S-7/...	Part 35503  .../D/H/S-7/...	
					Part 33457  .../D/H/S-7/...	Part 33678  .../D/H/S-7/...			
Part 32701  .../S-10/... (ohne Gehäuse)	Part 33290  .../D/H/S-10/...	Part 33444  .../D/H/S-10/...	Part 33764  .../D/H/S-10/...		Part 32920  .../D/H/S-10/...	Part 33688  .../D/H/S-10/...		Part 35904  .../D/H/S-10/...	Part 37799  .../D/H/S-10/...
					Part 33448  .../D/H/S-10/...	Part 33679  .../D/H/S-10/...			
	Part 33439  .../D/H/2x S-5/...	Part 33440  .../D/H/2x S-5/...	Part 44630  .../D/H/2x S-5/...		Part 33543  .../D/H/2x S-5/...	Part 33680  .../D/H/2x S-5/...			

Technical changes possible without prior notification. Prices and delivery time on request.

















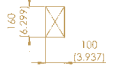

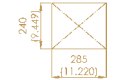





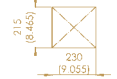

ATS 21xx-Matrix*

Manual Test Fixtures MA 21xx	Standard-Version		ESD-Version		FR4-Version
	With internal Intermediate Interface	Without internal Intermediate Interface	With internal Intermediate Interface	Without internal Intermediate Interface	With internal Intermediate Interface
Basic Units **					
MA 2109	 ATS 2109/S-5 Part 34140 Part 34140-KIT	 ATS 2009 Part 34270 Part 34270-KIT	 ATS 2109/S-5/ESD Part 38830 Part 38830-KIT	 ATS 2009/ESD Part 37645 Part 37645-KIT	 ATS 2109/S-5/FR4 Part 39318 Part 39318-KIT
MA 2111 MA 2111/HG	 ATS 2111/S-5 Part 32450 Part 32450-KIT	 ATS 2011 Part 31750 Part 31750-KIT	 ATS 2111/S-5/ESD Part 38832 Part 38832-KIT	 ATS 2011/ESD Part. 37641 Part 37641-KIT	 ATS 2111/S-5/FR4 Part 38573 Part 38573-KIT
MA 2112 MA 2112/HG	 ATS 2112/S-7 Part 32340 Part 32340-KIT	 ATS 2012 Part 32330 Part 32330-KIT	 ATS 2112/S-7/ESD Part 34850 Part 34850-KIT	 ATS 2012/ESD Part 34495 Part 34495-KIT	 ATS 2112/S-7/FR4 Part 39316 Part 39316-KIT
MA 2112 MA 2112/HG (only for pneumatic dual-stage contacting)	 Dual-stage Retrofit Kit MA 2112*** Part 34660  ATS 2112-2/S-7 Part 34820 Part 34820-KIT				
MA 2113 MA 2113/HG	 ATS 2113/S-10 Part 31440 Part 31440-KIT	 ATS 2013 Part 32605 Part 32605-KIT	 ATS 2113/S-10/ESD Part 38835 Part 38835-KIT	 ATS 2013/ESD Part 38667 Part 38667-KIT	 ATS 2113/S-10/FR4 Part 39320 Part 39320-KIT
MA 2113 MA 2113/HG (only for pneumatic dual-stage contacting)	 Dual-stage Retrofit Kit MA 2113*** Part 38790  ATS 2113-2/S-10 Part 39055 Part 39055-KIT				
MA 2113T MA 2113T/HG	 ATS 2111/S-5 Part 32450 Part 32450-KIT	 ATS 2011 Part 31750 Part 31750-KIT	 ATS 2111/S-5/ESD Part 38832 Part 38832-KIT	 ATS 2011/ESD Part 37641 Part 37641-KIT	 ATS 2111/S-5/FR4 Part 38573 Part 38573-KIT
MA 2114	 ATS 2114/S-10 Part 34490 Part 34490-KIT	 ATS 2014 Part 34345 Part 34345-KIT	 ATS 2114/S-10/ESD Part 38931 Part 38931-KIT	 ATS 2014/ESD Part 38930 Part 38930-KIT	 ATS 2114/S-10/FR4 Part 39319 Part 39319-KIT

* delivery condition: Part: XXXXX-KIT = ATS is delivered completely demounted (standard delivery condition)
Part: XXXXX = ATS is delivered completely mounted (on request)

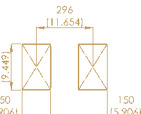
** with or without Test System Interface

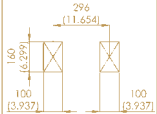
*** needed only once

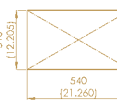
		Rigid-Pin-Version		RF-Version			
		Usable Area		Usable Area		Usable Area	
	Without internal Intermediate Interface		With internal Intermediate Interface		With internal Intermediate Interface	Without internal Intermediate Interface	
	ATS 2009/FR4 Part 39443 Part 39443-KIT						
	ATS 2011/FR4 Part 39441 Part 39441-KIT						
	ATS 2012/FR4 Part 39440 Part 39440-KIT						
							
	ATS 2013/FR4 Part 39437 Part 39437-KIT						
							
	ATS 2011/FR4 Part 39441 Part 39441-KIT						
	ATS 2014/FR4 Part 39435 Part 39435-KIT						

Technical changes possible without prior notification. Prices and delivery time on request.

MA 21xx/ATS 21xx-Additional Components

With the additional components for Manual Test Fixture series MA 21xx the individual functionality of the Manual Test Fixtures can be extended. Ideally the additional components are mounted

during the initial customizing, but they also can be mounted at a later time.



Part No. 29805
Anti-pinch Protection for MA 21xx
(Standard at MA 2112, MA 2113, MA 2113T and MA 2114)



Part No. 33840
Check NDH closed with micro switch on MA 21xx (Release force of the micro switch approx. 0.1 N)



Part No. 33465
Check NDH closed with two spring-loaded Test Probes and ground-screw on ATS 21xx (Spring force per spring-loaded Test Probe approx. 1.5 N)



Part No. 33510
Check NDH closed with micro switch on ATS 21xx (Release force of the micro switch approx. 0.1 N)



Part No. 32665
Locking unit NDH closed with stroke magnet NC on MA 21xx (24 V-11 W – currentless closed)

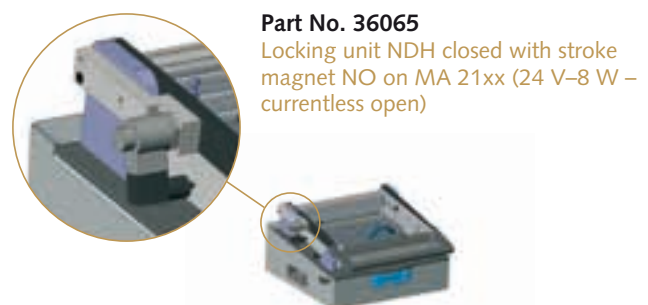

Part No. 36065
Locking unit NDH closed with stroke magnet NO on MA 21xx (24 V-8 W – currentless open)

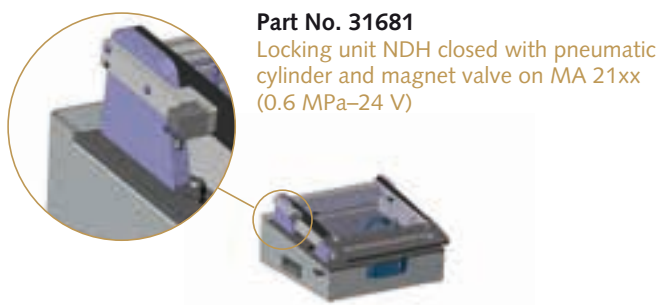

Part No. 31681
Locking unit NDH closed with pneumatic cylinder and magnet valve on MA 21xx (0.6 MPa-24 V)

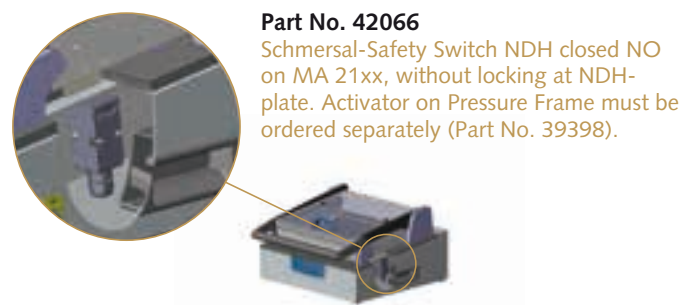

Part No. 42066
Schmersal-Safety Switch NDH closed NO on MA 21xx, without locking at NDH-plate. Activator on Pressure Frame must be ordered separately (Part No. 39398).

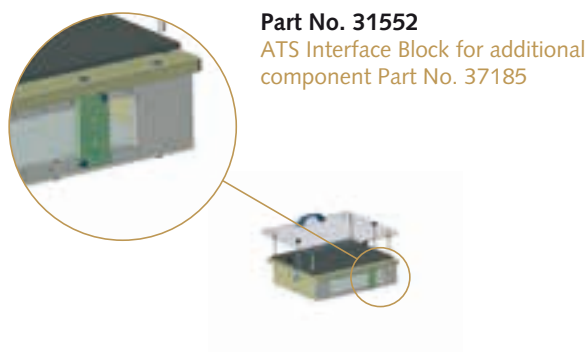
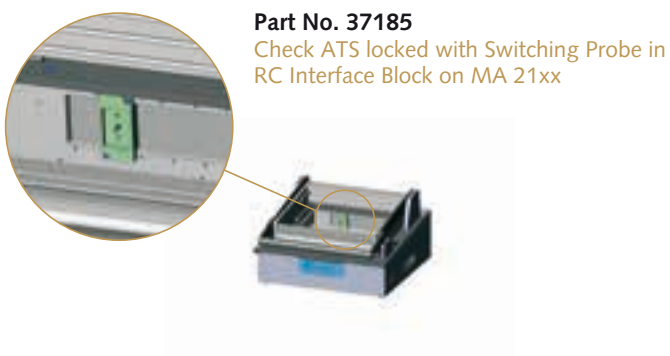
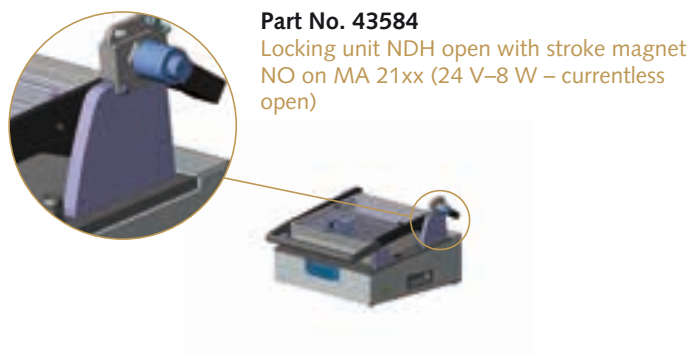
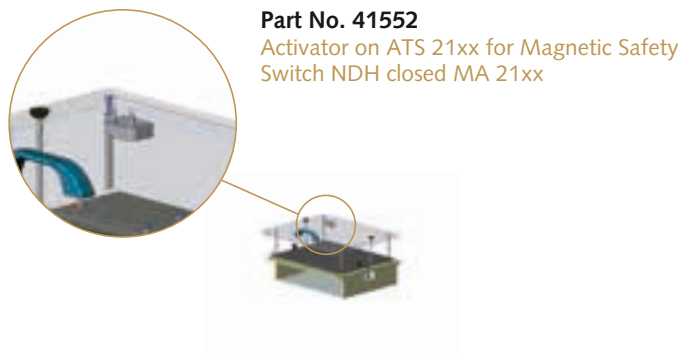
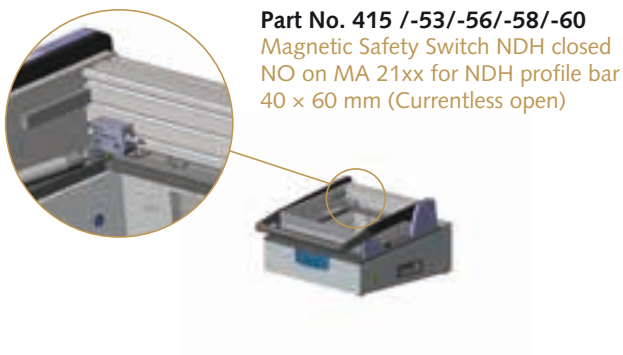
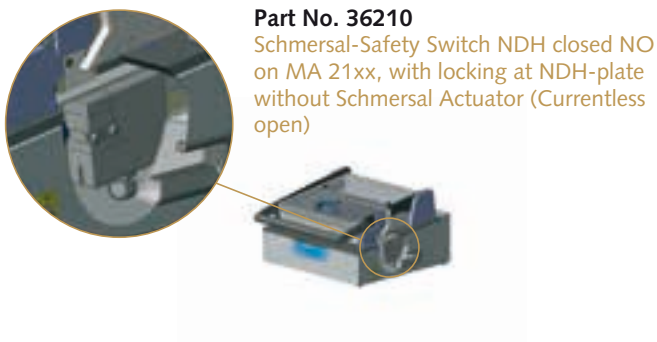

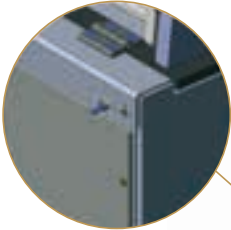

Part No. 40509, 398/-51/-52/-53/-54/-55
Protection conductor wiring for MA 21xx
Part No. 418/-09/-11/-12/-13/-14
Contact protection for ATS 2xxx
(Assembly according to DIN EN 60204-1)

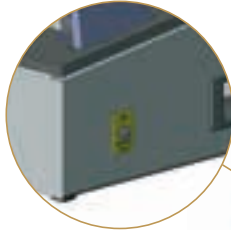
Part No. 33482
ESD-assembly according to
DIN EN 61340-5-1 on MA 21xx with Test
Certificate (Initial assembly)



Part No. 29233
Automatic Connector Approach
Mechanism SAM-Mini-07 for ATS 21xx
(Stroke approx. 7 mm at parallel stroke of
ATS 21xx with 7 mm)





Part No. 34934
NDH stiffener bar for ATS 2111/ATS 2112
Part No. 34499
NDH stiffener bar for ATS 2113/ATS2114





Part No. 42700
Self-opener Retrofit Kit for MA 2111 to MA
2114
Part No. 42701
Self-opener Retrofit Kit for MA 2109





Part No. 42704
Oil brake Retrofit Kit for MA 2111 to
MA 2114

Part No. 40980
Cover cap push-button for MA 21xx (For
individual assembly with push-buttons: red
(33467), yellow (33466), green (33468) –
not included in delivery)

Part No. 42703
MA-Control Unit (incl. D-Sub Connector)
To control the standardized and optionally
available Additional Components for
Manual Test Fixture series MA 21xx



Fixture customizing MA 21xx

For standard customizing the following components are, for example, necessary:

- Basic Unit
- Replacement Kit
- a minimum of 10 Pushrods
- 4 Pre-registration Pins
- 2 Tooling Pins
- 10 PC-Board Support Disks
- 2 Interface Blocks for customizing of Base Unit (≙ 340 Signal Transfers)
- 2 Interface Blocks for customizing of Replacement Kit (≙ 340 Signal Transfers)
- Test Probes and Receptacles (see INGUN Test Probes Catalog)

The customizing components are designed for a standard installation height of 10.5 mm.

When customizing yourself, then the applicable Fixture customizing components can be purchased separately from INGUN.

Detailed drawing of customized MA Fixture

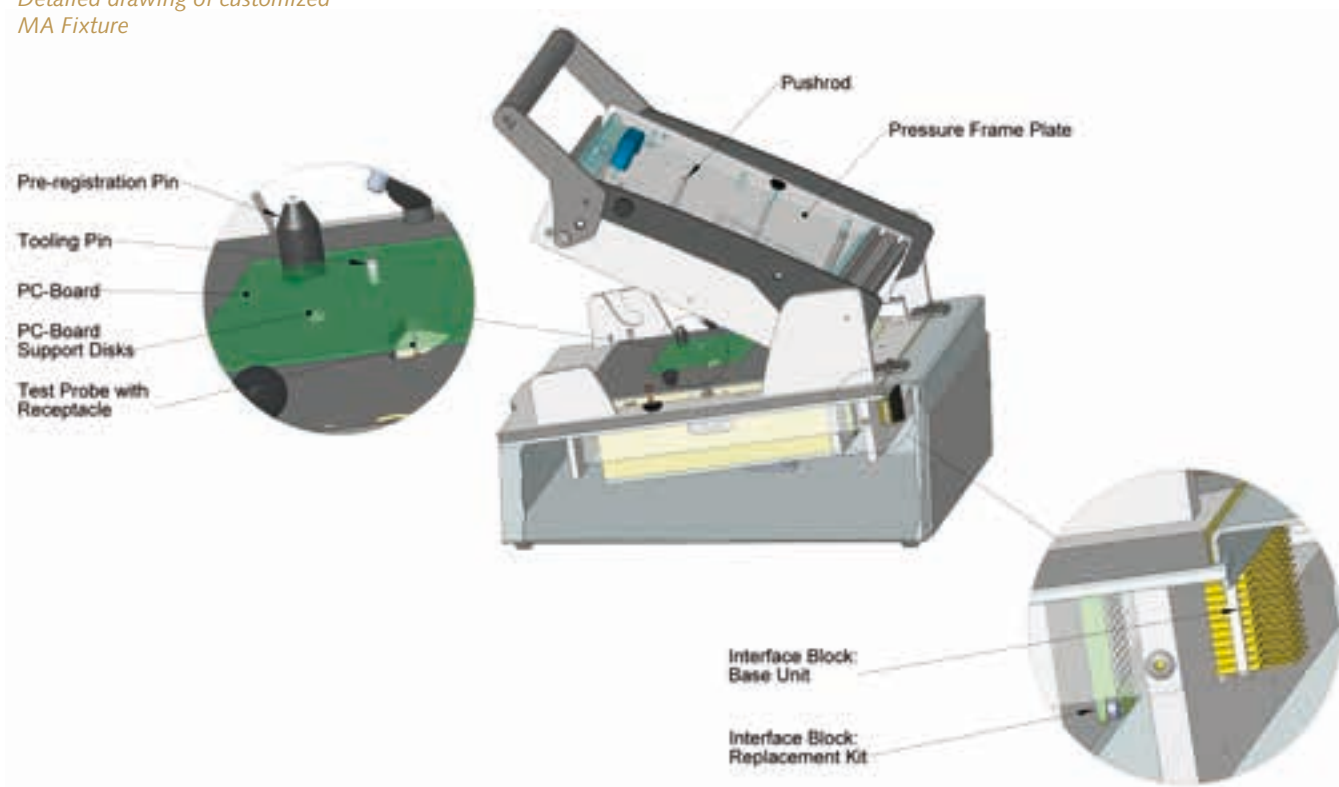

The Test Probes Catalog



You can find more information about our Test Probes on our homepage www.ingun.com.

We will also be pleased to send you our new catalog.

The Test Probe Catalog with a large choice of Cable Test Probes

In the new catalog you will find the largest choice of Test Probes: High-current Probes, Fine-pitch Probes, Short-stroke Probes, Interface Probes, Rotating Probes, Switching Probes, Pneumatic Probes and many more.

Apart from this there is a separate section with numerous new Test Probes for Cable Harness Testing – from Screw-in High-current Probes through to Push-back Probes.

Pneumatic Test Fixtures

PAZ 100/D/H (on request)

Part No. 41061 (Basic Unit)	PAZ 100/D/H	Outside Dimensions: 460 × 320 × 280 mm (w × d × h)
Part No. 41062 (Replacement Kit)	ATS for PAZ 100 with Interchangeable Pressure-Frame Plate, Probe Plate, spring-loaded PCB-Mounting Plate, Wiring Protection Cover	Usable Area: 270 × 110 mm

PAZ 200/D/H

Part No. 13694 (Basic Unit)	PAZ 200/D/H	Outside Dimensions: 550 × 458 × 270 mm (w × d × h)* Contact Force: up to 1.000 N
Part No. 13988 (Replacement Kit)	ATS for PAZ 200 with Interchangeable Pressure-Frame Plate, Probe Plate, spring-loaded PCB-Mounting Plate, Wiring Protection Cover and Interface Frame prepared for mounting of up to 8x 64-pole VG-strips	Usable Area: 230 × 200 mm
Part No. 19562 (Basic Unit)	PAZ 200/D/H/680	Outside Dimensions: 550 × 458 × 276 mm (w × d × h)* Contact Force: up to 1.000 N
Part No. 15918 (Replacement Kit)	ATS for PAZ 200/680 with Interchangeable Pressure-Frame Plate, Probe Plate, spring-loaded PCB-Mounting Plate, Wiring Protection Cover and Interface Frame prepared for mounting of up to 680 Transfer Pins	Usable Area: 230 × 190 mm (w × d)

PAZ 200-2/D/H

Part No. 17856 (Basic Unit)	PAZ 200-2/D/H, dual-stage Test Fixture	Outside Dimensions: 550 × 458 × 270 mm (w × d × h)
Part No. 18967 (Basic Unit)	PAZ 200/D/H, extended Usable Area	Outside Dimensions: 550 × 440 × 270 mm (w × d × h)
Part No. 18968 (Replacement Kit)	ATS for PAZ 200 with extended Usable Area	Usable Area: 260 × 200 mm

* Details see page 30

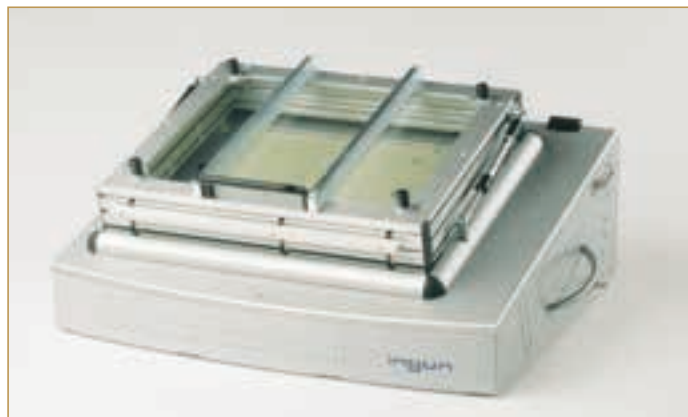

PA 2130



Drive details of series PAZ

PAZ 215/D/H		
Part No. 18956 (Basic Unit)	PAZ 215/D/H	Outside Dimensions: 550 × 458 × 270 mm (w × d × h) Contact Force: 1.500 N
Part No. 18958 (Replacement Kit)	ATS for PAZ 215 with Interchangeable Pressure-Frame Plate, Probe Plate, spring-loaded PCB-Mounting Plate, Wiring Protection Cover	Usable Area: 250 × 200 mm
PA 2130/D/H		
Part No. 20598 (Basic Unit)	PA 2130/D/H	Outside Dimensions: 550 × 458 × 270 mm (w × d × h) Contact Force: 700 N (e.g. 350 TP × 2N)
Part No. 17640 (Replacement Kit)	KTE 2130 Probe Plate Unit with spring-loaded PCB-Mounting Plate and Interchangeable Pressure-Frame Plate, Wiring Protection Cover	Usable Area: 240 × 220 mm Outside Dimensions: 325 × 255 × 50 (w × d × h)

PAZ 200/D/H
with ATS PAZ 200

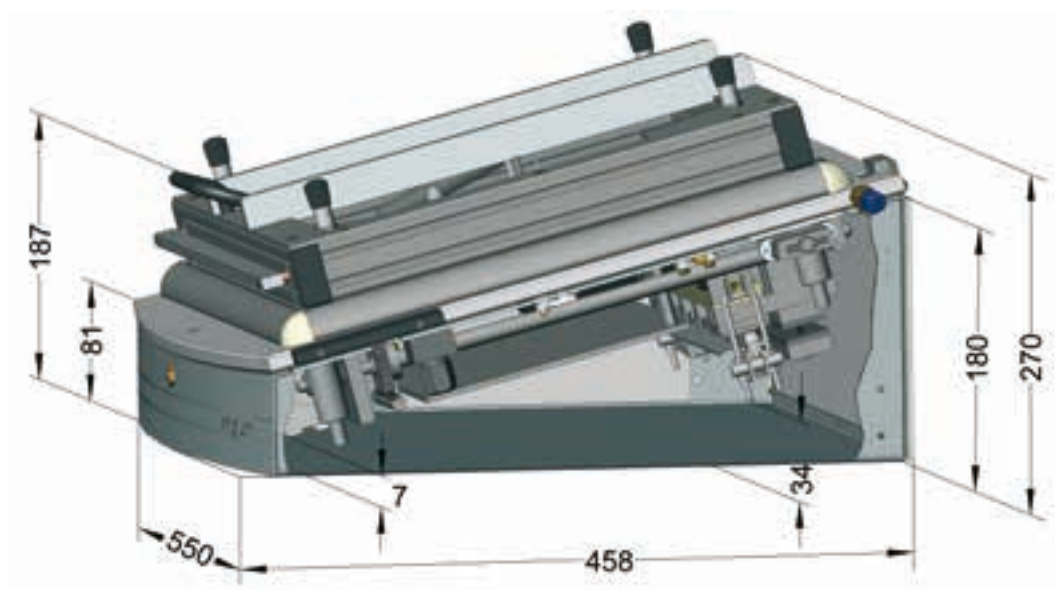

PA 2130/D/H
with KTE PA 2130

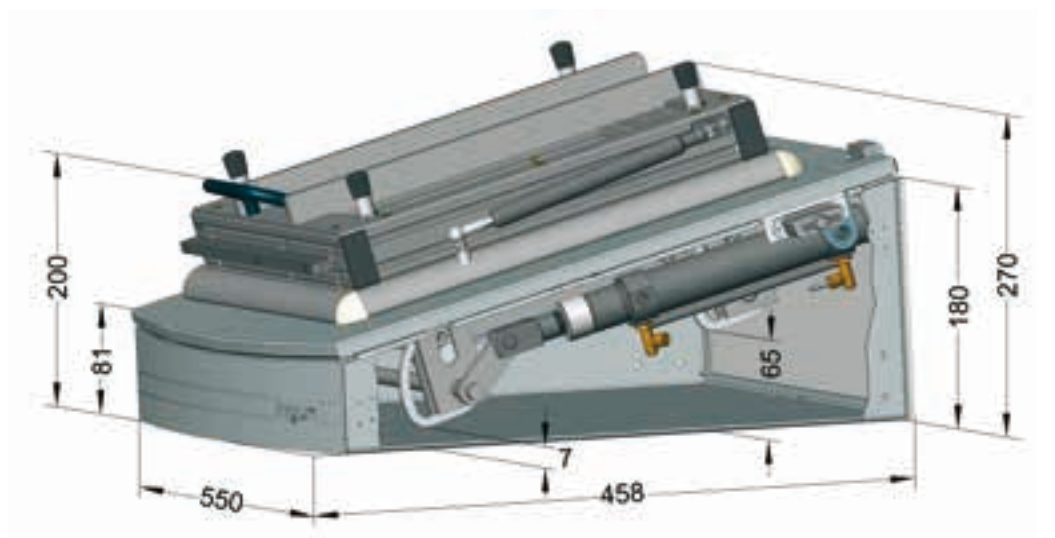

For standard customizing the following components are, for example, necessary:

- Basic Unit
- Replacement Kit
- a minimum of 10 Pushrods
- 4 Pre-registration Pins
- 2 Tooling Pins
- 10 PC-Board Support Disks
- 2 Interface Blocks for customizing of Base Unit (≙ 340 Signal Transfers)
- 2 Interface Blocks for customizing of Replacement Kit (≙ 340 Signal Transfers)
- Test Probes and Receptacles (see INGUN Test Probes Catalog)

The customizing components are designed for a standard installation height of 10.5 mm.

When customizing yourself, the applicable Fixture customizing components can be purchased separately from INGUN.

Detailed drawing of customized PAZ 200/D/H

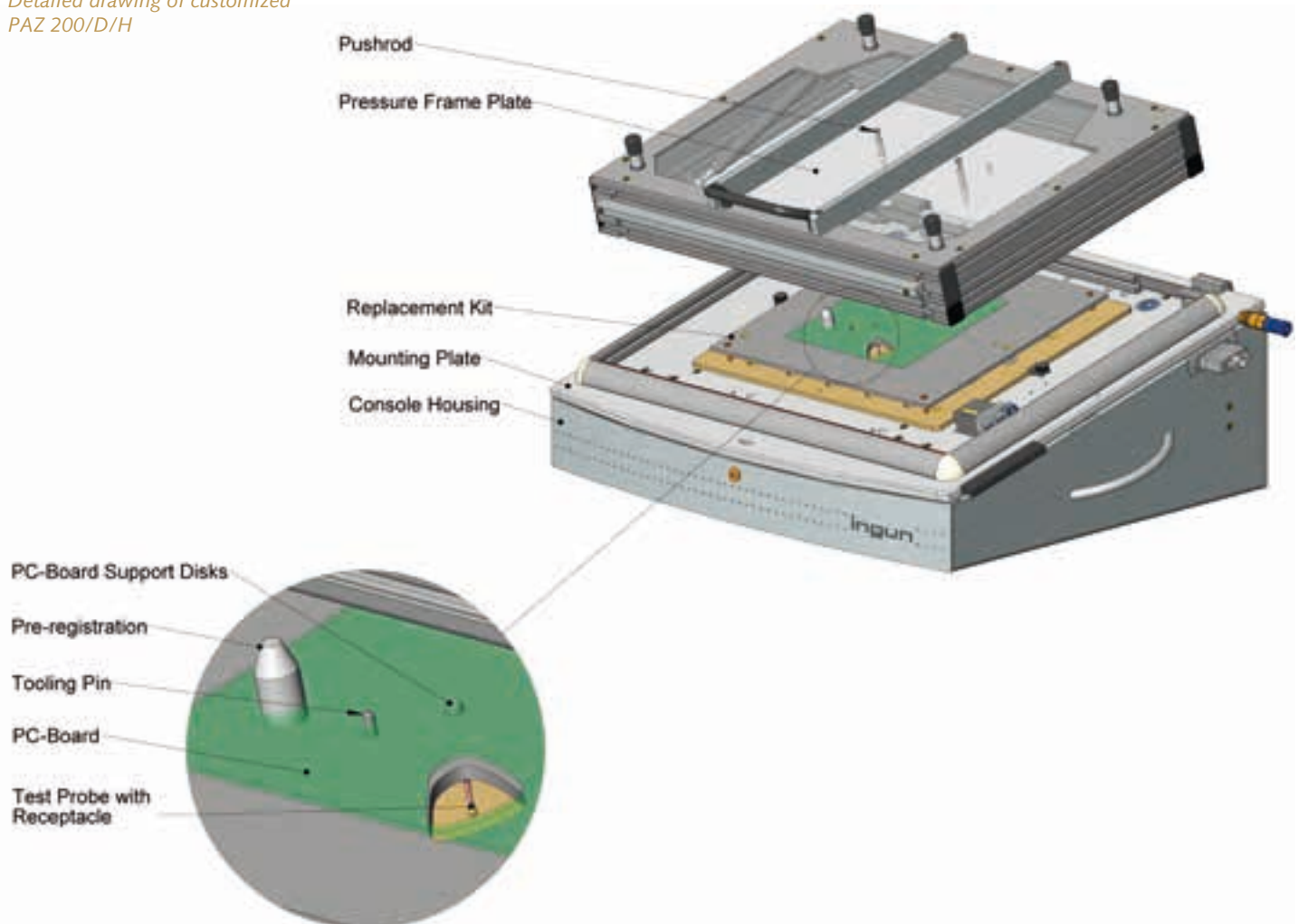

INGUN Radio-frequency Test Fixtures

The INGUN Radio-frequency Test Fixtures are developed and manufactured in accordance to customer demands. They allow testing of highly sensitive PC-Boards without electro-magnetic noise influences.



Radio-frequency Test Fixture based on MA 2111 with ATS 2111/HF

The UUT is completely shielded to the outside; both for the measurement as well as to protect the operator. Because the attenuation values determine the volume of the test chamber, then these must be known to enable design and manufacturing of the RF Fixture.

The signals, which must be measured on the PC-Board, are passed from the inside through the RF-cover to the outside via INGUN RF-Probes and then on to the Test System.

The new RF-Probes Catalog

Optimal test solutions for your ambitious analog and digital RF-Applications.



Besides general mechanical and electrical data, INGUN provides s-parameter measurement graphs for several product types in the 2012/2013 edition of the RF catalog.

You can find a downloadable version of the catalog on our website www.ingun.com

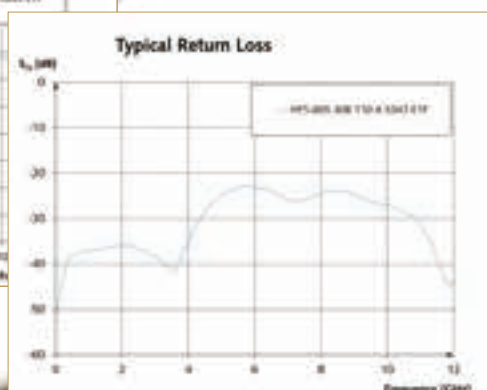
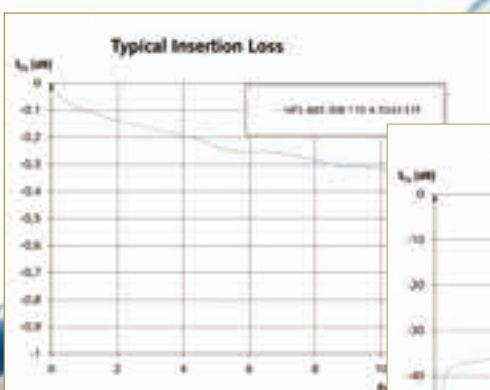

Vacuum Test Fixtures

The vacuum Test Fixtures from INGUN are designed as either an individual Fixture Kit or with an Interchangeable Kit. The intermediate interfaces of the Interchangeable Kits are equipped with Test Probes. Interfaces are available for all common Test Systems. Depending on the size of the UUT, you can choose from a wide range of suitable vacuum-cassette sizes.

Dual-stage Fixtures with a motor-driven shuttle plate are available for combined In-Circuit and Functional Test. In addition, there

are two standard vacuum cassette sizes: The VA 2030 and the VA 2040 as well as the dual-stage variants 2501-2 and 2601-2. Further cassette sizes can also be supplied. A large range of Pressure Frame Units and standardized Vacuum Covers allow simple customizing using standard components. Apart from customized Vacuum Fixtures, INGUN also supplies individual Fixture Kits for your own customizing work. Furthermore, customizing items such as Pushrods, Tooling Pins, Spacers, Vacuum Couplings etc. are also supplied (see pages 57–61).

The following Vacuum Fixture models (single-stage) are available for customizing:

VA 2030		Usable Area: 340 × 210 mm
VA 2040		Usable Area: 430 × 310 mm
VA 2130	Tandem Version with two separate vacuum chambers	Usable Area: 130 × 215 mm (each)
VA 2140	Tandem Version with two separate vacuum chambers	Usable Area: 170 × 330 mm (each)
VIN 423	Interchangeable Fixture	Usable Area ATS: 380 × 230 mm
VIN 2040	Interchangeable Fixture for 11 Interface Pin Block	Usable Area ATS: 400 × 270 mm

The following dual-stage Test Fixtures (equipped with Shuttle Plate) are available for combined ICT/FCT:

VA 2501-2	dual-stage Test Fixture	Usable Area: 300 × 170 mm
VA 2601-2	dual-stage Test Fixture	Usable Area: 390 × 290 mm
VIN 423-2/D/H	Interchangeable Fixture/dual-stage Version	Usable Area ATS: 365 × 250 mm
VIN 2040	dual-stage Test Fixture	Usable Area ATS: 350 × 250 mm

On the following pages you will find a choice of our Vacuum and Manual Test Fixtures for the following Test Systems and Interfaces:





Vacuum Test Fixtures

Part No. 9904	VA 2040/F/H/MC 4200/4210	Usable Area: 440 × 340 mm; Outside Dimensions: 550 × 515 × 110 mm (w × d × h)
Part No. 12736	VA 2140/F/H/MC 4200/4210 (dual-stage Version)	Usable Area: 180 × 340 mm (per chamber, left/right); Outside Dimensions: 550 × 515 × 110 mm (w × d × h)
Part No. 18210	VA 2601-2/E/F/H/MC 4200/4210 (dual-stage Version)	Usable Area: 390 × 300 mm; Outside Dimensions: 550 × 515 × 115 mm (w × d × h)
Part No. 30625	VA 2040/F/H/Aeroflex 4200/4250	Usable Area: 440 × 330 mm; Outside Dimensions: 550 × 450 × 120 mm (w × d × h)

Manual Test Fixtures MA 21xx

Part No. 33750	MA 2112/F/H/S-7/Aeroflex 4200/4250	Outside Dimensions: 485 × 560 × 275 mm (w × d × h)
Part No. 37736	MA 2113/F/H/S-10/Aeroflex 4200/4250	Outside Dimensions: 620 × 600 × 300 mm (w × d × h)

Further variants available on request. Replacement Kits see page 11 and 13.

Ausbauteile für QTest-2 Aeroflex

Part No. 33064	QMUX
Part No. 12570	Test Jet 1.2 complete with Test Probes
Part No. 12571	Test Jet 2.5 complete with Test Probes
Part No. 12315	Sensor Plates B-C Size (Capacitors)
Part No. 12316	Sensor Plates D Size (Capacitors)
Part No. 33065	CMUX 8
Part No. 33066	CMUX 32

Schnittstellenmaterial

Part No. 9408	Contact Terminal KT 158 02-flat
----------------------	---------------------------------

Test Fixtures for further Aeroflex Test Systems on request.



VA 2040/F/H/MC 4200



Vacuum Test Fixtures		
Part No. 10932	VA 2040/D/H/MTS 100	Usable Area: 430 × 310 mm; Outside Dimensions: 550 × 450 × 150 mm (w × d × h)
Part No. 8234	VA 2030/D/H/MTS 200	Usable Area: 340 × 220 mm; Outside Dimensions: 460 × 330 × 150 mm (w × d × h)
Part No. 4758	VA 2040/D/H/MTS 200	Usable Area: 430 × 310 mm; Outside Dimensions: 550 × 450 × 150 mm (w × d × h)
Part No. 16509	VA 2601-2/E/D/H/MTS 200 (dual-stage Version)	Usable Area: 390 × 300 mm; Outside Dimensions: 550 × 450 × 155 mm (w × d × h)
Part No. 18000	VA 2040/D/H/MTS 300	Usable Area: 390 × 300 mm; Outside Dimensions: 575 × 510 × 175 mm (w × d × h)
Part No. 18510	VA 2601-2/E/D/H/MTS 300 (dual-stage Version)	Usable Area: 390 × 300 mm; Outside Dimensions: 575 × 510 × 175 mm (w × d × h)

Vacuum Interchangeable Fixtures		
Part No. 18060	VIN 423/D/H/MTS 300 (Interchangeable Fixture)	Outside Dimensions (Basic Unit): 575 × 510 × 170 mm (w × d × h)
Part No. 1385	ATS 423 (Replacement Kit) for VIN 423/D/H/MTS 300 (Interchangeable Fixture)	Usable Area: 410 × 250 mm
Part No. 18512	VIN 423-2/D/H/MTS 300 (Interchangeable Fixture/dual-stage Version)	Outside Dimensions (Basic Unit): 575 × 760 × 250 mm (w × d × h)
Part No. 18364	ATS 423-2 (Replacement Kit dual-stage) for VIN 423-2/D/H/MTS 300 (Interchangeable Fixture/dual-stage Version)	Usable Area: 390 × 230 mm
Part No. 31269	VIN 2040/D/H/MTS 300 (can also be used as dual-stage Base Unit)	Outside Dimensions: 575 × 510 × 170 mm (w × d × h)

Further details of the VIN see page 49 and 50.

Manual Test Fixtures MA 21xx		
Part No. 33045	MA 2112/D/H/S-7/MTS 100	Outside Dimensions: 540 × 515 × 270 mm (w × d × h)
Part No. 32958	MA 2112/D/H/S-7/MTS 300	Outside Dimensions: 575 × 580 × 255 mm (w × d × h)
Part No. 33443	MA 2113/D/H/S-10/MTS 300	Outside Dimensions: 620 × 585 × 265 mm (w × d × h)
Part No. 33380	MA 2113T/D/H/2x S-5/MTS 300	Outside Dimensions: 620 × 530 × 265 mm (w × d × h)

Further variants available on request. Replacement Kits see page 11, 13 and 15.

Customizing parts Digitaltest/OpensCheck

Part No. 18748 Opens Check complete Digitaltest

Part No. 20544 Opens Check Connector

Part No. 24335 Opens Check Standard

Interface Materials

Part No. 13001 Male Connector 32-way a/c for
MTS 100 – Assembly of Interface

Part No. 3650 Contact Terminal KT 158 for MTS 200
and 300 – Assembly of Interface



VA 2040/D/H/MTS 300



Vacuum Test Fixtures

Part No. 4844*	VA 2070/S/HP 3070 (Assembly Kit)	Usable Area: 300 × 390 mm; Outside Dimensions: 450 × 460 × 80 mm (w × d × h); PCB support pin: Row 01/23, Column 00/80
Part No. 10319	VA 2171/S/HP 3070 (Tandem-Version)	Usable Area: 120 × 390 mm (per chamber, left/right); Outside Dimensions: 450 × 460 × 80 mm (w × d × h); PCB support pin: Row 01/23, Column 00/25 + 55/80
Part No. 8326	VA 2073/L/HP 3070	Usable Area: 680 × 390 mm; Outside Dimensions: 815 × 460 × 80 mm (w × d × h); PCB support pin: Row 01/23, Column 00 left/80 right
Part No. 14251	VA 2070-2/E/S/HP 3070 (dual-stage Test Fixture)	Outside Dimensions: 450 × 460 × 85 mm (w × d × h); PCB support pin: Row 01/23, Column 00/75
Part No. 18084	VA 2070/S/HP 3070 incl. ZSK 2070 (with additorial Contacting from above)	Usable Area: 280 × 310 mm; Outside Dimensions: 520 × 550 × 200 mm (w × d × h); PCB support pin: Row 04,4/21, Column 02/77
Part No. 25522	VA 2073/L/HP 3070 incl. ZSK 2073 + Stroke counter	Usable Area: 640 × 310 mm; Outside Dimensions: 815 × 460 × 200 mm (w × d × h)
Part No. 4998	VA 2041/S/HP 3070	Usable Area: 320 × 240 mm (w × d) Outside Dimensions: 450 × 460 × 80 mm (w × d × h)

Additional Contacting Units ZSK 207x/HP3070

Part No. 31291	ZSK 2070/HP3070 incl. V-Sealing Usable Area: approx. 280 × 340 mm (w × d)
Part No. 22108	ZSK 2073/HP3070 incl. V-Sealing Usable Area: approx. 640 × 340 mm (w × d)
Part No. 31294	Assembly Set for ZSK 2070/HP3070 with FR4-plate (10 mm)
Part No. 33536	Assembly Set for ZSK 2073/HP3070 with FR4-plate (10 mm)



VA 2041/S/HP 3070
Part No. 4998

Further housing sizes and customizing variants available. Further details of the Additional Contacting Unit ZSK see page 55.

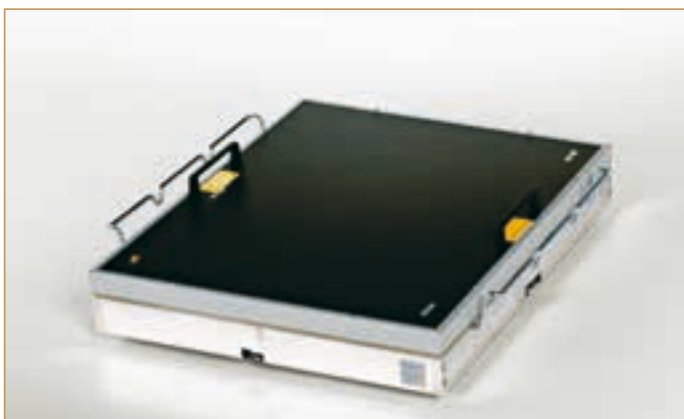

Fixture Kit VA 2070/S/HP 3070

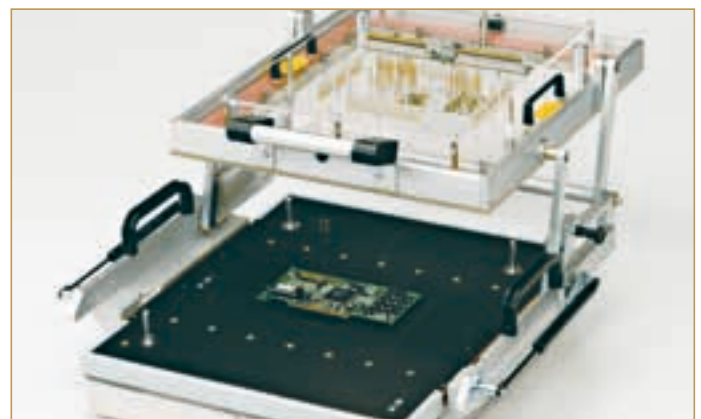

VA 2070/S/HP 3070 incl. ZSK
Part No. 18084

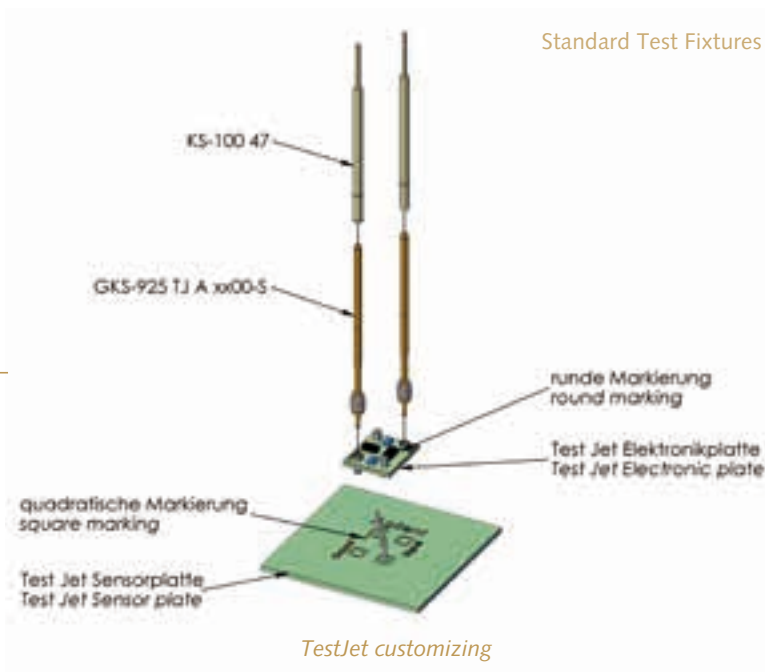

Customizing parts Agilent

TestJet customizing:

Pressure Frame Unit for Test Jet (cannot be used for customizing with Vacuum-free zone)

Part No. 15266	NDH Test Jet 1 (Europe Format) Standard-Version for approx. 10 Test Jets	Usable Area: 180 × 140 mm (w × d)
Part No. 15241	NDH Test Jet 2 (Double-Europe Format) Standard-Version for approx. 25 Test Jets	Usable Area: 250 × 200 mm (w × d)
Part No. 39447	NDH Test Jet 1/ESD (Europe Format) ESD-Version for approx. 10 Test Jets	Usable Area: 180 × 140 mm (w × d)
Part No. 39696	NDH Test Jet 2/ESD (Double-Europe Format) ESD-Version for approx. 25 Test Jets	Usable Area: 250 × 200 mm (w × d)

TestJet customizing materials (including Receptacle KS)

Part No. 9681	Signal-Conditioner Modul 2 Top side MUX 1 card	
Part No. 14038	Signal-Conditioner-Board Modul 0 Top side MUX & REF 1 card	
Part No. 12570	TestJet 1.2, complete	Size: 32.0 × 32.0 mm (w × d)
Part No. 12571	TestJet 2.5, complete	Size: 65.0 × 65.0 mm (w × d)

Polarity-Check customizing materials (including Receptacle KS)

Part No. 12318	HP Polarity-Check, B-C Size, complete	Size: 6.4 × 3.8 mm (w × d)
Part No. 12319	HP Polarity-Check, D Size, complete	Size: 7.7 × 5.0 mm (w × d)

Connector-Test customizing materials

Part No. 12574	Connector-Test, complete	Size: 31.5 × 12.7 mm (w × d)
-----------------------	--------------------------	------------------------------

VTEP Accessories

Part No. 23777	Signal-Conditioner-Board	FIX-VTEP	
Part No. 23778	Electronic plate N4301A-FG	FIX-VTEP	
Part No. 23779	Sensor plate 1.2 inch (= 30.5 mm)	FIX-VTEP	
Part No. 24956	Probe Set N4301A-FG	FIX-VTEP	Includes Part No. 23778 and 2x GKS-925 TJA 1000-S
Part No. 23871	VTEP 1.2 complete	FIX-VTEP	Includes Part No. 23779, Part No. 24956 and 2x KS-100 47

INGUN Vacuum Cover:

Part No. 17560	Vacuum Cover 12, PVC antistatic, transparent	Outside Dimensions: 340 × 390 × 75 mm (w × d × h)
Part No. 17261	Vacuum Cover 10, PVC antistatic, transparent	Outside Dimensions: 175 × 404 × 72 mm (w × d × h)
Part No. 17469	Vacuum Cover 11, PVC antistatic, transparent	Outside Dimensions: 175 × 245 × 72 mm (w × d × h)
Part No. 15534	Vacuum Cover 2, PVC antistatic, transparent	Outside Dimensions: 390 × 360 × 75 mm (w × d × h)

Fixture customizing with Vacuum-free Zone:

Part No. 33769	Pressure Frame Unit 2070-09	Outside Dimensions: 385 × 390 × 75 mm (w × d × h) Inner Dimensions: 345 × 350 × 60 mm (w × d × h)
Part No. 15972	Pressure Frame Unit 2171/left/right (2 pcs. needed)	Outside Dimensions: 185 × 390 × 70 mm (w × d × h) Inner Dimensions: 145 × 350 × 60 mm (w × d × h)
Part No. 17696	Pressure Frame Unit 2073 incl. PVC anti-static, transparent	Outside Dimensions: 700 × 390 × 100 mm (w × d × h) Inner Dimensions: 660 × 350 × 60 mm (w × d × h)
Part No. 11369	Pressure Frame Unit 23/1 incl. PVC anti-static, transparent	Outside Dimensions: 325 × 255 × 70 mm (w × d × h) Inner Dimensions: 285 × 215 × 60 mm (w × d × h)

The Pressure Frame Units are suitable at height for mounting additional Test Jet components.

For PC-Board customizing with Pressure Frame Unit and Vacuum-free Zone and for the PC-Board thickness of 1.6 mm the following Pushrods are used:

Part No. 17324	Pushrods 55.6 rigid, green, Ø 2,5	Dimensions: 55.6 mm long
Part No. 19419	Pushrods 55.6 rigid, green, Ø 6,0	Dimensions: 55.6 mm long

Interface Materials:**Fixture Interface Contact Terminals**

Part No. 7015	Personality Pin 44275 P (Original Agilent component)
----------------------	--

Test System Interface Probe

GKS-100 306 229 A 1000	Spring force: 1 N
-------------------------------	-------------------

Further customizing components see pages 57 to 61.

Manual Test Fixtures MA 21xx

Part No. 42600	MA 2113/D/H/S-10/Agilent i 1000	Outside Dimensions: 620 × 585 × 270 mm (w × d × h)
-----------------------	---------------------------------	--

Vacuum Test Fixtures

Part No. 17293	VA 2035/D/H/Reinhardt	Usable Area: 350 × 308 mm; Outside Dimensions: 420 × 400 × 230 mm (w × d × h)
Part No. 12421	VA 2040/D/H/Reinhardt	Usable Area: 440 × 340 mm; Outside Dimensions: 550 × 515 × 110 mm (w × d × h)
Part No. 20892	VIN 423/D/H/Reinhardt	Outside Dimensions: 550 × 515 × 170 mm (w × d × h)
Part No. 1385	ATS 423 (Replacement Kit)	Usable Area: 410 × 250 mm
Part No. 31074	VIN 2040/F/H/Reinhardt	Outside Dimensions: 550 × 622 × 246 mm (w × d × h)

Manual Test Fixtures MA 21xx

Part No. 32735	MA 2112/D/H/S-7/Reinhardt VG12	Outside Dimensions: 550 × 580 × 260 mm (w × d × h)
Part No. 38871	MA 2113/D/H/S-10/Reinhardt VG12	Outside Dimensions: 620 × 655 × 280 mm (w × d × h)

Further variants available on request. Replacement Kits see page 11 and 13.

Interface Materials

Part No. 8256	Female connector STV-c-64-F-a/c wiring side (Replacement Kit and Basic Unit)
Part No. 11438	Male Connector STV-c-64-M-a/c Interface (Replaceable Part)



VA 2035/D/H/Reinhardt



Vacuum Test Fixtures		
Part No. 4116	VA 2030/F/H/Pylon 9.6	Usable Area: 340 × 220 mm; Outside Dimensions: 480 × 370 × 90 mm (w × d × h)
Part No. 1226	VA 2040/F/H/Pylon 9.6	Usable Area: 430 × 340 mm; Outside Dimensions: 550 × 490 × 90 mm (w × d × h)
Part No. 16124	VA 2040/F/H/Pylon 9.6 for 19"	Vacuum Fixture for 19" Housing Usable Area: 430 × 340 mm; Outside Dimensions: 550 × 535 × 90 mm (w × d × h)
Part No. 16001	VA 2601-2/E/F/H/Pylon 9.6 (dual-stage Version)	Usable Area: 390 × 300 mm; Outside Dimensions: 550 × 490 × 95 mm (w × d × h)
Part No. 16198	VA 2601-2/E/F/H/Pylon 9.6 for 19" (dual-stage Version)	Usable Area: 390 × 300 mm; Outside Dimensions: 550 × 535 × 95 mm (w × d × h)

Manual Test Fixtures MA 21xx		
Part No. 33681	MA 2112/D/H/S-7/Pylon 9.6	Outside Dimensions: 485 × 550 × 265 mm (w × d × h)
Part No. 33678	MA 2112/D/H/S-7/HG/Pylon 9.6	Outside Dimensions: 485 × 550 × 365 mm (w × d × h)
Part No. 33688	MA 2113/D/H/S-10/Pylon 9.6	Outside Dimensions: 620 × 620 × 265 mm (w × d × h)
Part No. 33679	MA 2113/D/H/S-10/HG/Pylon 9.6	Outside Dimensions: 635 × 620 × 365 mm (w × d × h)
Part No. 33680	MA 2113T/D/H/2x S-5/Pylon 9.6	Outside Dimensions: 620 × 515 × 265 mm (w × d × h)

Further variants available on request. Replacement Kits see page 11, 13 and 15.

Interface Materials

Part No. 13515 S-ATS-170-06, Signal Block loaded with KT-158 06

Further Interface Blocks see on page 58.

Test System Interface Probe

GKS-945 357 106 A 1100



VA 2030/F/H/R&S



Vacuum Test Fixtures

Part No. 11981	VA 2020-1/D/Spea 501 (single-stage Version) without Interface	Usable Area: 375 × 280 mm; Outside Dimensions: 490 × 590 × 125 (front) mm
Part No. 20850	VA 2020-2/E/D/H/Spea 501 (dual-stage Version) without Interface	Usable Area: 375 × 280 mm; Outside Dimensions: 490 × 590 × 125 (front)/ 220 (back) mm
Part No. 28409	VA 2025/D/H/Spea 501	Usable Area: 375 × 450 mm; Outside Dimensions: 490 × 590 × 115 (front)/ 205 (back) mm
Part No. 23648	Fixture Kit Spea 3030/L, Multimode Test System	Usable Area: 470 × 350 mm; Outside Dimensions: 615 × 560 mm (w × d)

Manual Test Fixtures MA 21xx

Part No. 37970	MA 2112/S-7/Spea 3030 (without housing – for mounting on Test System)	Outside Dimensions: 460 × 545 × 110 mm (w × d × h)
Part No. 32701	MA 2113/S-10/Spea 3030 (without housing – for mounting on Test System)	Outside Dimensions: 620 × 615 × 110 mm (w × d × h)

Further variants available on request. Replacement Kits see page 11 and 13.

Customizing components for OpenPin-Test (Spea)

Part No. 32627	Escan Multiplexer 16 Channel
Part No. 32630	Escan-Probe-20 (Cable length 30 cm)
Part No. 33513	Escan-Probe-30 (Cable length 40 cm)
Part No. 33514	Escan-Probe-40 (Cable length 60 cm)
Part No. 33515	Escan-Probe-50 (Cable length 80 cm)
Part No. 33518	Captor10 4.7 mm
Part No. 33519	Captor11 5 × 9 mm
Part No. 33520	Captor12 5.2 × 10.4 mm
Part No. 33521	Captor13 6 × 14.1 mm
Part No. 33522	Captor14 7.5 × 12.9 mm
Part No. 33523	Captor15 10 × 21.1 mm
Part No. 33524	Captor16 10 × 18.4 mm
Part No. 33525	Captor17 10 × 27.5 mm
Part No. 33526	Captor18 12 × 18.4 mm
Part No. 33527	Captor19 13.8 × 19.6 mm
Part No. 33528	Captor20 27.5 × 27.5 mm
Part No. 33529	Captor21 35 × 35 mm



VA 2025/D/H/Spea 501



Vacuum Test Fixtures for 885x and SE-Series

Part No. 19219	VA 2030/F/H/TD 885x-S assembled for 1280 TP	Usable Area: 340 × 200 mm Outside Dimensions: 550 × 400 × 140 mm (w × d × h)
Part No. 15267	VA 2040/F/H/TD 885x-S Interface Panel assembled at front	Usable Area: 440 × 340 mm Outside Dimensions: 550 × 520 × 140 mm (w × d × h)
Part No. 14420	VA 2040/F/H/TD 885x-M assembled for 2560 TP	Usable Area: 440 × 340 mm Outside Dimensions: 550 × 520 × 140 mm (w × d × h)
Part No. 13898	VA 2601-2/E/F/H/TD 885x-M (dual-stage Version) assembled for 2560 TP	Usable Area: 400 × 300 mm Outside Dimensions: 550 × 520 × 145 mm (w × d × h)

Vacuum-Interchangeable Fixtures for 885x and SE-Series

Part No. 23870	VIN 423/F/H/TD 885x-S (Maximum Loading of Intermediate Interface: 2280 Terminals)	Outside Dimensions: 550 × 520 × 210 mm (w × d × h)
Part No. 14875	VIN 423/F/H/TD 885x-M (Maximum Loading of Intermediate Interface: 2280 Terminals)	Outside Dimensions: 550 × 520 × 210 mm (w × d × h)

Replacement Kit for Interchangeable Vacuum Test Fixture VIN 423

Part No. 1385	ATS 423 (Replacement Kit)	Usable Area: 410 × 250 mm
----------------------	----------------------------------	---------------------------

Vacuum Test Fixtures for 883x-Series and Z-18xx

Part No. 13516	VA 2030/D/H/Z18xx-M	Usable Area: 340 × 220 mm Outside Dimensions: 520 × 330 × 150 mm (w × d × h)
Part No. 13517	VA 2040/D/H/Z18xx-M	Usable Area: 440 × 340 mm Outside Dimensions: 550 × 450 × 150 mm (w × d × h)
Part No. 13520	VA 2040/D/H/Z18xx-L	Usable Area: 440 × 340 mm Outside Dimensions: 760 × 450 × 150 mm (w × d × h)

Tandem Vacuum Test Fixtures

Part No. 14877	VA 2140/D/H/Z18xx-M (Tandem Version)	Usable Area: 180 × 340 mm per chamber Outside Dimensions: 550 × 450 × 150 mm (w × d × h)
-----------------------	---	---



VA 2040/F/H/TD 885x-S

Manual Text Fixtures MA 21xx

Part No. 32965	MA 2112/F/H/S-7/TD 88xx-S	Outside Dimensions: 620 × 585 × 255 mm (w × d × h)
Part No. 33464	MA 2112/F/H/S-7/TD 88xx-M	Outside Dimensions: 620 × 585 × 255 mm (w × d × h)
Part No. 33290	MA 2113/D/H/S-10/TD 88xx-S	Outside Dimensions: 620 × 585 × 265 mm (w × d × h)
Part No. 33444	MA 2113/D/H/S-10/TD 88xx-M	Outside Dimensions: 620 × 585 × 265 mm (w × d × h)
Part No. 33439	MA 2113T/D/H/2x S-5/TD 88xx-S	Outside Dimensions: 620 × 530 × 265 mm (w × d × h)
Part No. 33440	MA 2113T/D/H/2x S-5/TD 88xx-M	Outside Dimensions: 620 × 530 × 265 mm (w × d × h)

Further variants available on request. Replacement Kits see page 11, 13 and 15.

Customizing accessories**FrameScan assembly accessories**

Part No. 31737	FrameScan FX 2.0 Selector Board
Part No. 31738	FrameScan FX 2.0 Selector Board incl. Assembly parts
Part No. 14762	FrameScan Plus Amplifier P/N 047-531-00
Part No. 14763	FrameScan Plus PCA, 0.375" × 0.475"
Part No. 14764	FrameScan Plus PCA, 0.425" × 0.575"
Part No. 14765	FrameScan Plus PCA, 0.500" × 6.25"
Part No. 14766	FrameScan Plus PCA, 1.25" × 1.25"
Part No. 14767	FrameScan Plus PCA, 2.56" × 2.56"
Part No. 19643	CapScan, B-C Size, complete, 6.4" × 3.8"
Part No. 19644	CapScan, D-Size, complete, 7.7" × 5.0"
Part No. 17238	FrameScan Plus PCA, 0.425" × 0.575"
Part No. 17239	FrameScan Plus PCA, 0.500" × 6.25"
Part No. 17240	FrameScan Plus PCA, 1.25" × 1.25"
Part No. 17241	FrameScan Plus PCA, 2.56" × 2.56"
Part No. 17242	FrameScan Plus PCA, 0.375" × 0.475"
Part No. 26486	FrameScan FX horizontal
Part No. 31735	FrameScan FX vertical
Part No. 31739	FrameScan FX horizontal, 1.25" × 1.25"

Interface accessories

Part No. 3650	KT 158 Contact Terminal for assembly in Interface (with mounting hole)
----------------------	--

Customizing parts Teradyne**FrameScan and CapScan – Customizing:****Pressure Frame Unit for FrameScan**

Part No. 15266	Usable Area: 180 × 140 mm (w × d)
Part No. 15241	Usable Area: 250 × 200 mm (w × d)
Part No. 39447	Usable Area: 180 × 140 mm (w × d)
Part No. 39696	Usable Area: 250 × 200 mm (w × d)

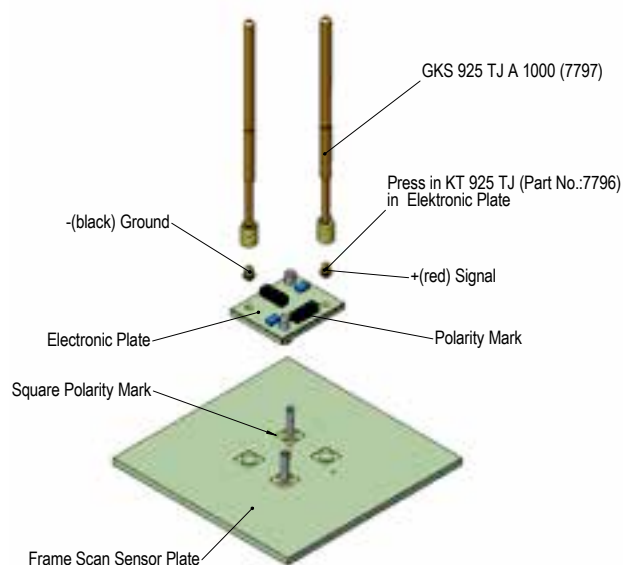

FrameScan



Vacuum Test Fixtures for TS 12x/LH/GR 228x		
Part No. 8852	VA 2040/F/H/GR 228x 15/07 Slots	Usable Area: 440 × 340 mm Outside Dimensions: 550 × 450 × 110 mm (w × d × h)
Part No. 12833	VA 2040/F/H/GR 228x 15/15 Slots	Usable Area: 440 × 340 mm Outside Dimensions: 550 × 450 × 100 mm (w × d × h)
Part No. 26140	VA 2040/F/H/GR 228x 18/07 Slots (512 TP)	Usable Area: 440 × 340 mm Outside Dimensions: 550 × 450 × 100 mm (w × d × h)
Part No. 15980	VA 2040/F/H/GR 228x 18/18 Slots	Usable Area: 440 × 340 mm Outside Dimensions: 550 × 450 × 110 mm (w × d × h)
Part No. 17013	VA 2601-2/E/F/H/GR 228x 15/15 Slots (dual-stage Version)	Usable Area: 390 × 300 mm Outside Dimensions: 550 × 450 × 115 mm (w × d × h)
Part No. 3802	VA 2030/F/H/GR 2270/71	Usable Area: 340 × 220 mm Outside Dimensions: 480 × 370 × 90 mm (w × d × h)
Part No. 3812	VA 2040/F/H/GR 2270/71	Usable Area: 440 × 340 mm Outside Dimensions: 567 × 488 × 92 mm (w × d × h)
Part No. 4672	VA 2130/F/H/GR 2270/71 (Tandem Version)	Usable Area: 130 × 200 mm per chamber (left/right) Outside Dimensions: 480 × 370 × 90 mm (w × d × h)
Part No. 4673	VA 2140/F/H/GR 2270/71 (Tandem Version)	Usable Area: 180 × 340 mm per chamber (left/right) Outside Dimensions: 550 × 490 × 90 mm (w × d × h)
Part No. 13963	VA 2601-2/E/F/H/GR 2270/71 (dual-stage Version)	Usable Area: 390 × 300 mm Outside Dimensions: 550 × 450 × 95 mm (w × d × h)

Manual Test Fixtures MA 21xx		
Part No. 44880	MA 2112/D/H/S-7/GR 228x 15/07	Outside Dimensions: 550 × 525 × 335 mm (w × d × h)
Part No. 37745	MA 2112/D/H/S-7/GR 228x 15/15	Outside Dimensions: 550 × 525 × 335 mm (w × d × h)
Part No. 33462	MA 2112/D/H/S-7/GR 2270/71	Outside Dimensions: 485 × 550 × 265 mm (w × d × h)
Part No. 33457	MA 2112/D/H/S-7/HG/GR 2270/71	Outside Dimensions: 485 × 550 × 365 mm (w × d × h)
Part No. 33764	MA 2113/D/H/S-10/GR 228x 15/07	Outside Dimensions: 620 × 585 × 335 mm (w × d × h)
Part No. 32920	MA 2113/D/H/S-10/GR 2270/71	Outside Dimensions: 635 × 620 × 265 mm (w × d × h)
Part No. 33448	MA 2113/D/H/S-10/HG/GR 2270/71	Outside Dimensions: 620 × 620 × 365 mm (w × d × h)
Part No. 44630	MA 2113T/D/H/2x S-5/GR 228x 15/07	Outside Dimensions: 620 × 515 × 335 mm (w × d × h)
Part No. 33543	MA 2113T/D/H/2x S-5/GR 2270/71	Outside Dimensions: 620 × 515 × 265 mm (w × d × h)

Further variants available on request. Replacement Kits see page 11, 13 and 15.

Customizing Accessories for Open Express

Part No. 19941	Open Express Board Kit (Viper, incl. Cable)
Part No. 22373	OFM BOARD for GenRad
Part No. 23433	Open Express 1.2

Contact Terminals for post-loading of Interface GR 228x

Part No. 17513	Contact Terminals for Signal Field
Part No. 3609	Contact Terminals for Power Field

Fixture Interface components GR 2270/71

Part No. 13515	S-ATS-170-06, Signal Block (Contact Terminal with bore hole)
----------------	--

Test System Interface Probe

GKS 938 307 180 A 1500

Dr. Eschke Elektronik

Vacuum Test Fixtures

Part No. 25818	VA 2030/D/H/Pylon 9.6	Usable Area: 340 × 220 mm Outside Dimensions: 483 × 352 × 151 mm (w × d × h)
Part No. 15481	VA 2040/D/H/Pylon 9.6	Usable Area: 440 × 340 mm Outside Dimensions: 567 × 475 × 153 mm (w × d × h)
Part No. 4116	VA 2030/F/H/Pylon 9.6	Usable Area: 340 × 220 mm Outside Dimensions: 480 × 370 × 90 mm (w × d × h)
Part No. 1226	VA 2040/F/H/Pylon 9.6	Usable Area: 440 × 340 mm Outside Dimensions: 567 × 488 × 92 mm (w × d × h)
Part No. 4979	VA 2030/D/H	Usable Area: 340 × 210 mm Outside Dimensions: 460 × 340 × 153 mm (w × d × h)
Part No. 4980	VA 2040/D/H	Usable Area: 430 × 310 mm Outside Dimensions: 550 × 441 × 157 mm (w × d × h)

Manual Test Fixtures MA 21xx

Part No. 33681	MA 2112/D/H/S-7/Pylon 9.6	Outside Dimensions: 485 × 550 × 265 mm (w × d × h)
Part No. 33678	MA 2112/D/H/S-7/HG/Pylon 9.6	Outside Dimensions: 485 × 550 × 365 mm (w × d × h)
Part No. 33688	MA 2113/D/H/S-10/Pylon 9.6	Outside Dimensions: 620 × 620 × 265 mm (w × d × h)
Part No. 33679	MA 2113/D/H/S-10/HG/Pylon 9.6	Outside Dimensions: 635 × 620 × 365 mm (w × d × h)
Part No. 33680	MA 2113T/D/H/2x S-5/Pylon 9.6	Outside Dimensions: 620 × 515 × 265 mm (w × d × h)
Part No. 32162	INGUN Pylon-Receiver	Outside Dimensions: 500 × 605 × 95 mm (w × d × h)

Further variants available on request. Replacement Kits see page 11, 13 and 15.

The backpanel of the **VA 20x0 – Basic Units** and the **MA 21xx – Basic Units** (pages 9, 10, 11, 13, 15, 16, 34) can be individually machined for mounting e.g. 50-pole Sub-D connectors.

Accessories for Pin Scan available.

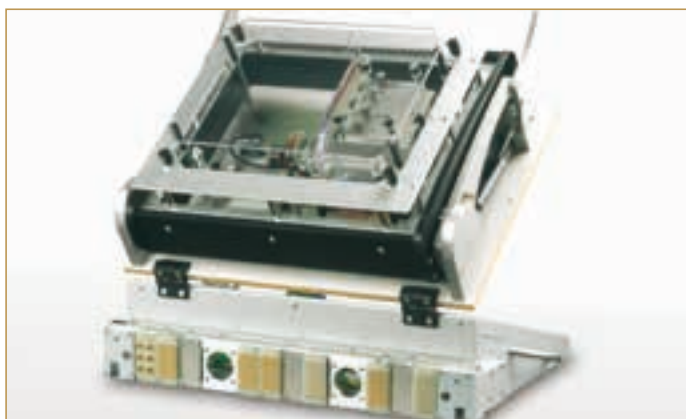

Individual loading of Pylon Interface

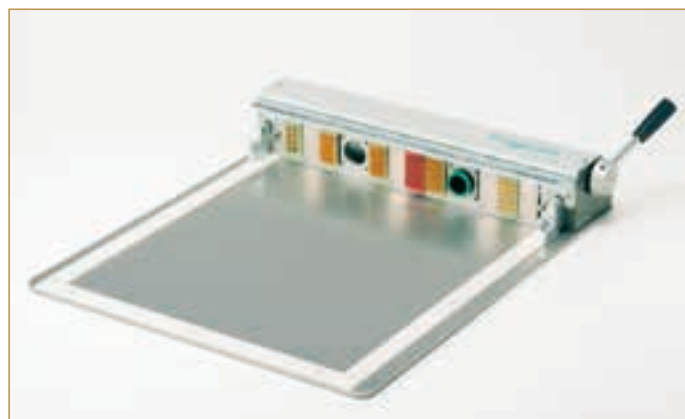

INGUN Pylon-Receiver (variable assembly of operating lever possible)



Vacuum Test Fixtures with VPC Virginia Panel Interface

Part No. 26639	VA 2040/D/H/VPC-G12	Usable Area: 440 × 340 mm
Part No. 27148	VA 2030/F/H/VPC-G12	Usable Area: 340 × 220 mm
Part No. 27149	VA 2040/D/H/VPC-G20	Usable Area: 440 × 340 mm
Part No. 24369	VA 2030/F/H/VPC-S6	Usable Area: 340 × 220 mm

Vacuum Interchangeable Fixture

Part No. 32115	VIN 2040/D/H/VPC-G20 without Interface	Usable Area: 350 × 250 mm
-----------------------	--	---------------------------

Manual Test Fixtures MA 21xx

Part No. 33040	MA 2112/D/H/S-7/VPC-S6	Outside Dimensions: 460 × 500 × 265 mm (w × d × h)
Part No. 35503	MA 2112/D/H/S-7/VPC-G12-12	Outside Dimensions: 460 × 560 × 265 mm (w × d × h)
Part No. 35904	MA 2113/D/H/S-10/VPC-G12-12	Outside Dimensions: 620 × 635 × 265 mm (w × d × h)
Part No. 37799	MA 2113/D/H/S-10/VPC-G12-18	Outside Dimensions: 620 × 620 × 270 mm (w × d × h)
Part No. 33480	MA 2112/D/H/S-7/HG/KT-ITA-21	Outside Dimensions: 460 × 545 × 365 mm (w × d × h)

Further variants available on request. Replacement Kits see page 11 and 13.

Interface Materials

Part No. 23944	VPC Connector, 192-way, not loaded
Part No. 24595	Contact Terminal for VPC Connector
Part No. 22910	Connector 19-pole for Power Contact
Part No. 22911	Power Contact, mini, JTA 50 Amp.

The VPS Interfaces are used among other for customized Test Systems from Rohde & Schwarz, Gedis and Konrad.

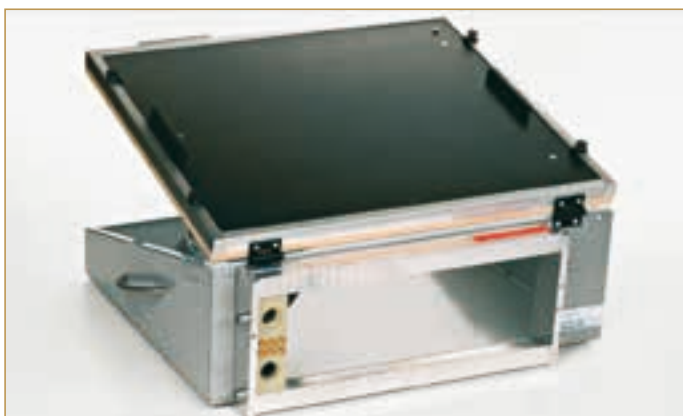

VA 2040/D/H/VPC-G20

Vacuum Interchangeable Fixture VIN 2040

The Vacuum Fixture with Interchangeable Kit VIN 2040 consists of a Basic Unit and an Interchangeable Kit.

The signal transfer is achieved via a modular designed Intermediate Interface that is float-mounted in the Basic Unit and fixed-mounted in the Interchangeable Kit. The Intermediate Interface is designed for INGUN Interface Blocks. The Interface Blocks are assembled vertically and are therefore resistant to contamination. A maximum of eleven Interface Blocks can be used. This offers transfer of a maximum of 1870 signals.

The set-up for new testing demands is quick and easy and requires no external tools. The Interchangeable Kit is inserted into the Basic Unit from above. By pushing back the lever on the side, the Interchangeable Kit Cassette is guided to the back of the Fixture until the Intermediate Interface is closed and then locked in place. An additional catch-pin secures the position of the Interchangeable Kit Cassette. The Intermediate Interface is opened by first unlocking the catch-pin and then pulling the lever towards the operator into the changing position.

The Interchangeable Cassette Kit can be hinged open like all INGUN Test Fixtures and therefore allows good access to the internal wiring.

The Vacuum Interchangeable Fixture VIN 2040 is available for many common Test System Interfaces and in both ICT and FCT (dual-stage) designs. The FCT design is based on a shuttle plate with an electric motor drive.

Most used INGUN Interface Blocks

- 170-pole Signal Block
 - 24-pole High-current Block
 - 15-pole Radio-frequency Block
 - 8-pole Compressed Air Block
 - 45-pole Beam Waveguide Block
- (further information see page 58)

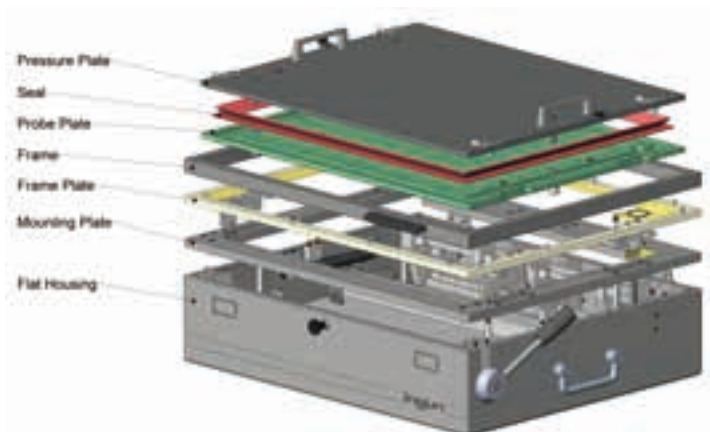

Detailed drawing of VIN 2040

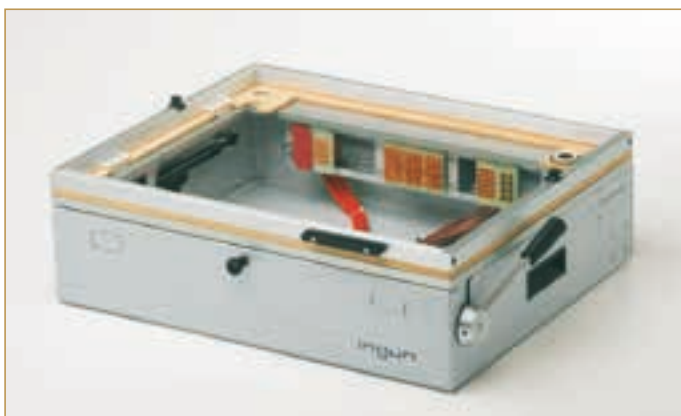

Basic Unit VIN 2040/F/H

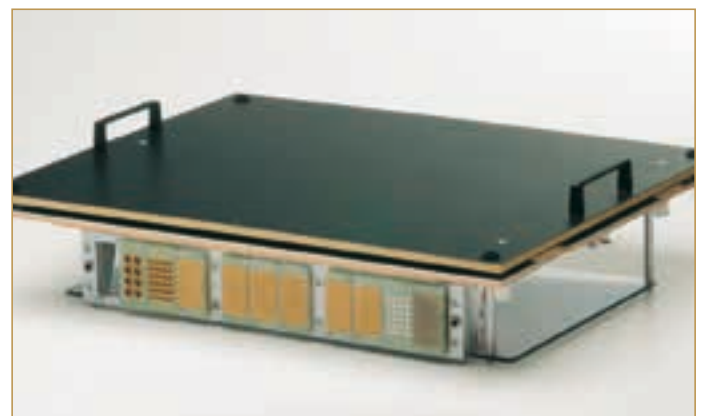

Interchangeable Kit ATS VIN 2040

Ordering Information		
Basic Unit	Replacement Kit	
	Single-stage Customizing	Dual-stage Customizing
VIN 2040/D/H/MTS300 Outside Dimensions: 575 × 510 × 210 mm (w × d × h) Part No. 31269	ATS VIN 2040-1 Usable Area: 400 × 270 mm (w × d) Part No. 31270	ATS VIN 2040-2 Usable Area: 350 × 250 mm (w × d) Part No. 31076
VIN 2040/F/H/Reinhardt Outside Dimensions: 550 × 622 × 246 mm (w × d × h) Part No. 31074		
VIN 2040/F/H Outside Dimensions: 550 × 450 × 192 mm (w × d × h) Part No. 27584	ATS VIN 2040 Usable Area: 430 × 270 mm (w × d) Part No. 27585	

Interface combinations available for all common Test Systems:



Detailed dimensional drawing of the VIN 2040

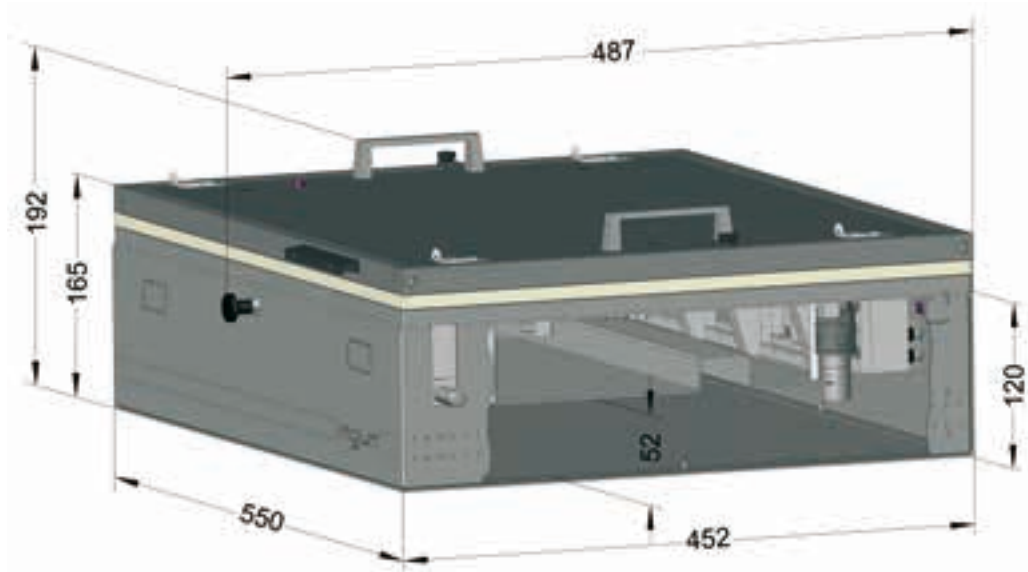

Rigid-Pin Test Fixture – Reliable contacting even in the smallest testing grid

The Rigid-Pin Fixture is used for reliable contacting of test points with a high spring force – even in the smallest testing grid. The Rigid-Pin Fixture consists of a standard Vacuum Fixture with spring-loaded Test Probes, which can be individually placed in a grid field, and of a geometrically matched interchangeable Rigid-Pin Cassette with Rigid-Pins that are deflected to a certain angle.

The deflection of the Rigid-Pins to a certain angle is calculated each time by the automatic conversion of the test points, which must be contacted on the grid field. The conversion of the test points is carried out at INGUN.

This special design and the precise guiding of the Rigid-Pins in the Rigid-Pin Cassette through to the test point, enable reliable contacting even in the smallest testing grid.

For contacting Test Pads, Vias and Component Pins, among others the Rigid-Pins with the tip-styles 01 (30° point), 06 (serrated), 07 (tri-hedral) and 14 (self-cleaning 4-point crown) are available.

The Rigid-Pin Fixture is available for all common Test System Interfaces.

Special Features:

- Contacting of testing grids down to 0.60 mm (24 Mil)*
- Contacting with an accuracy of \varnothing TK = 0.40 mm (16 Mil)
- Contacting on Pads, Vias, Pins
- Simple replacement of the Rigid-Pins without tools
- Compatible to Bead Probe Technology
- Testing methods such as e.g. TestJet and Polarity-Check can be integrated with special INGUN Rigid-Pins
- INGUN Marking Units (Part No. 24456) and Operating Elements can be easily integrated
- Also available with dual-stage customizing (ICT/FCT).

* Smaller grids available

Rigid-Pin Test Fixtures VSN

Part No. 27735	VSN 2030/F/H	Overall Size: 460 × 330 mm (w × d) Max. PCB Size: 305 × 155 mm (w × d); Max. Useable Area: 290 × 140 mm (w × d)
Part No. 27737	VSN 2040/F/H	Overall Size: 550 × 450 mm (w × d) Max. PCB Size: 365 × 295 mm (w × d); Max. Useable Area: 350 × 280 mm (w × d)
Part No. 27779	VSN 2070/F/H	Overall Size: 405 × 460 mm (w × d) Max. PCB Size: 275 × 325 mm (w × d); Max. Useable Area: 260 × 310 mm (w × d)

Rigid-Pin Replacement Kits for Manual Test Fixtures MA 21xx

Part No. 33335	ATS 2112/S-7/SN	Overall Size: 460 × 446 mm (w × d) Max. PCB Size: 255 × 220 mm (w × d); Max. Useable Area: 255 × 220 mm (w × d)
-----------------------	-----------------	--

Further variants available on request.



VSN 2070/F/H

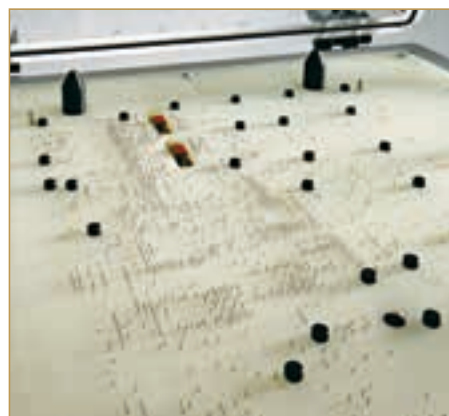

Rigid-Pin Application



MA 2112/D/H/S-7/Reinhardt VG12 with
ATS 2112/S-7/SN

Vacuum-sealed Covers

The Vacuum-sealed Covers from INGUN are used for PC-Boards that cannot be sealed with a standard sealing gasket, i.e. PC-Boards with complicated, irregular shapes or with numerous cut-outs and/or open-vias.

The sealing of Vacuum-sealed Covers is carried out by means of round-cord that is set into the under-side around the outside edges of the cover. Access to the PC-Board under test is not possible.

Customizing Parts for Vacuum Test Fixtures:

Part No. 15533	Vacuum Cover 1 (12 mm Wall thickness)	Outside Dimensions: 300 × 215 × 72 mm (w × d × h) Inner width: 276 × 191 × 60 mm (w × d × h)
Part No. 15534	Vacuum Cover 2 (15 mm Wall thickness)	Outside Dimensions: 390 × 360 × 75 mm (w × d × h) Inner width: 360 × 330 × 60 mm (w × d × h)
Part No. 15535	Vacuum Cover 3 (15 mm Wall thickness)	Outside Dimensions: 370 × 220 × 75 mm (w × d × h) Inner width: 340 × 190 × 60 mm (w × d × h)
Part No. 23504	Pushrods 55.6 rigid, green*	55.6 mm long; Ø 2.5 mm
Part No. 19419	Pushrods 55.6 rigid, green*	55.6 mm long; Ø 6.0 mm
Part No. 5107	Round-cord	Ø 3 mm

Further Covers can be found in our Fixture Accessories catalog.

* For PCB thickness 1.6 mm



Vacuum-sealed Cover

PCB-customizing with Vacuum-free Zone

The Vacuum-free Zone for single- or dual-stage customizing with the PCB-specific Pressure Frame System from INGUN is an alternative to customizing with a Vacuum Cover. The advantage of this type of customizing is the possibility of access to the PC-Board in the contacted state by means of cut-outs in the Pressure Frame Plate.

When using the Vacuum-free Zone method then, apart from the seal, a more stable and rigid Pressure Frame Unit is necessary, which then compensates the forces bearing down on the PC-Board.

The size of the Vacuum-free Zone depends on the outside dimensions of the PC-Board to be tested and is manufactured individually.

Part No. 000512 Vacuum free Zone made of silicone (single-stage); variabel, manufacturing dimensions according to customer demands. (Outside Dimensions of PCB)

Part No. 000513 Vacuum free Zone made of silicone (dual-stage); variabel, manufacturing dimensions according to customer demands. (Outside Dimensions of PCB)



Dual-stage Test fixture with Vacuum-free Zone



Pressure Frame open

Additional Contacting Unit ZSK 320/420 for Vacuum Test Fixture

The Vacuum Test Fixture System for double-sided contacting allows double-sided contacting of Bare PC-Boards, Mixed-loaded PC-Boards and SMD-loaded PC-Boards. Contacting from above is achieved in one operation by means of the hinged Additional Contacting Unit ZSK. This ZSK-Unit can be used with the Vacuum Test Fixtures series VA 320/420 and also VIN 323/423.

The ZSK-Unit is mounted onto the Vacuum Test Fixture using four screws. During the final phase of the hinged movement the ZSK-Unit moves vertically downwards towards the guide pins. In the case of components $\geq 10\text{mm}$ the ZSK Probe Plate (i.e. upper-side) of the Additional Contacting Unit must be milled out in accordance to the applicable PC-Board geometry and assembly.

The Wiring Guard is made of ESD-suitable material. The Additional Contacting Unit (ZSK) from INGUN excels itself with light weight, easy opening and closing as well as its ergonomic design.

The sealing around the circumference of the cassette makes separate PC-Board specific sealing superfluous. The contacting accuracy of the unit is achieved by means of three ball-bearing bushes and the parallel guiding of the floating Probe Plate.

The transfer of the test point wiring is carried out by means of a transfer field with Receptacles series KS-112 47 and Test Probes series GKS-912 207 180 A 1502 (assembly in the lower Probe Plate) and Contact Terminals series KT-254 W3 E03 (assembly in upper Probe Plate).

Part No. 4205	Additional Contacting Unit ZSK 420 VA/VIN	Outside Dimensions: 550 × 395 × 65 mm (w × d × h); ZSK-Mechanics without customizing parts
Part No. 18345	Additional Contacting Unit ZSK 320 VA/VIN	Outside Dimensions: 370 × 265 × 65 mm (w × d × h); ZSK-Mechanics without customizing parts
Part No. 1407	Replacement Kit ATS-ZSK 423-1	Usable Area: 315 × 240 mm; for VIN with ZSK
Part No. 1408	Replacement Kit ATS-ZSK 323	Usable Area: 250 × 175 mm; for VIN with ZSK
Part No. 10092	Customization Kit to ZSK 420	Usable Area: 315 × 240 mm; ZSK-Probe Plate incl. Customizing Parts

For VIN 423 the following parts are needed:

Part No. 4205	Additional Contacting Unit ZSK 420 VA/VIN
Part No. 1407	Replacement Kit ATS-ZSK 423-1
Part No. 10092	Customization Kit to ZSK 420

For VA 420 the following parts are needed:

Part No. 4205	Additional Contacting Unit ZSK 420 VA/VIN
Part No. 10092	Customization Kit for ZSK 420
Part No. 12704	Assembly Kit for ZSK 420

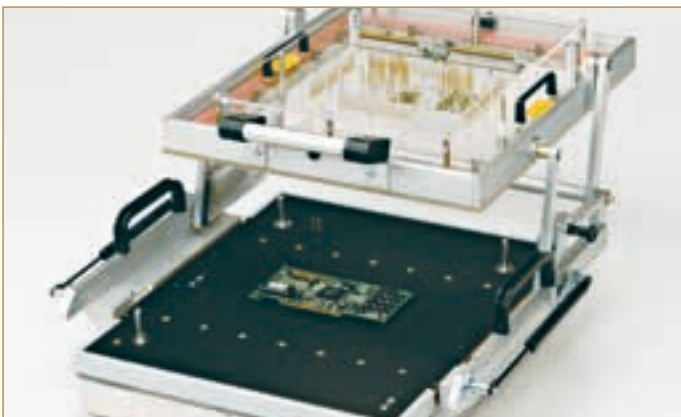

VA 2070/S/HP 3070 incl. ZSK
Part No. 18084

Additional Contacting Unit ZSK 2xxx-ADP for Vacuum Test Fixtures

The compact Additional Contacting Unit (ZSK) for Vacuum Fixtures is mounted onto the PCB Support Plate and allows exact contacting of both sides of the PC-Board. The main features of this product model are the light weight, the easy usage and the ergonomic design.

The parallel stroke of 10 mm ensures that the Test Probes always move vertical to the Test Points. Due to its float-mounted Probe Plate, which during the stroke is guided by at least three high-precision guide-pins, a high level of contacting accuracy is achieved.

Technical Data*:

Parallel Stroke:	10 mm
Opening Angle:	approx. 90°
Installation Height of Probes:	10.5 mm
Working Stroke of Probes:	4.3 mm

Max. component height on the top (component) side of the PCB:	
without machining of the Probe Plate:	≤ 5.0 mm
with machining of the Probe Plate:	≤ 15.0 mm

The guiding of the hinged Additional Contacting Unit is carried out manually and is supported by gas struts, which are assembled on both sides. The opening angle is almost 90°. The sealing lip around the outside of the Unit mean that customized sealing of the PC-Board is not necessary. A knurled screw, which is secured against loss, ensures transport safety.

The Test Fixtures are available in ICT-and FCT-versions. The FCT-version (dual-stage) is based on a shuttle plate electro-drive design.

Transfer Probes:

Probe Plate-“Top”:	KT-254 W3 E12
Probe Plate-“Bottom”:	KS-100 47 G
Probe Plate-“Bottom”:	GKS-100 307 150 A 2000

Accessories:

Part No. 25856: Pushrods 15 mm long, Ø 5 mm,
Mounting Dimensions Test Probes 10.5 mm

* Dimensions under laboratory conditions. Dimensions with height of Probe Support Pin (PAS) = 2.8 mm and thickness of PCB = 2.0 mm.

Ordering Information

Part No. 34546	ZSK 2030/EC-ADP (suitable for VA 2030)	Usable Area: 234 × 160 mm (w × d); Precision Guides: 3
Part No. 34597	ZSK 2040/EC-ADP (suitable for VA 2040)	Usable Area: 325 × 300 mm (w × d); Precision Guides: 4
Part No. 37141	ZSK 2160/EC-ADP (suitable for VA 2160)	Usable Area: 155 × 360 mm (w × d); Precision Guides: 4
Part No. 36484	ZSK 2800/EC-ADP (suitable for VA 2800)	Usable Area: 535 × 280 mm (w × d); Precision Guides: 4
Part No. 33550	ZSK 2070/EC-ADP (suitable for VA 2070/ HP3070)	Usable Area: 189 × 290 mm (w × d); Precision Guides: 4
Part No. 43070	ZSK 2171/EC-ADP (suitable for VA 2171/ HP3070)	Usable Area: 100 × 260 mm (w × d); Precision Guides: 3

Delivery note: Assembly Set and assembly drawing for the mounting on ADP are included

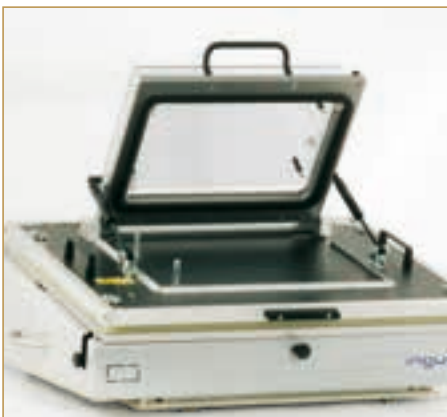

VIN 2040/D/H/MTS 300 with
ZSK 2040-ADP

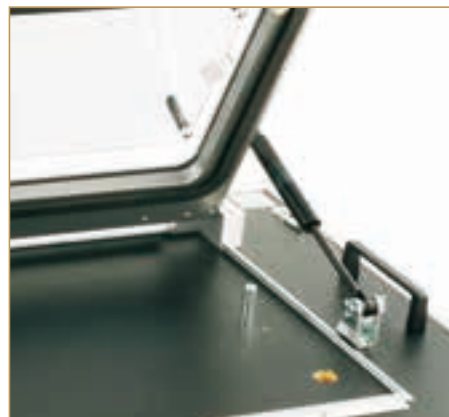

ZSK 2040-ADP opened

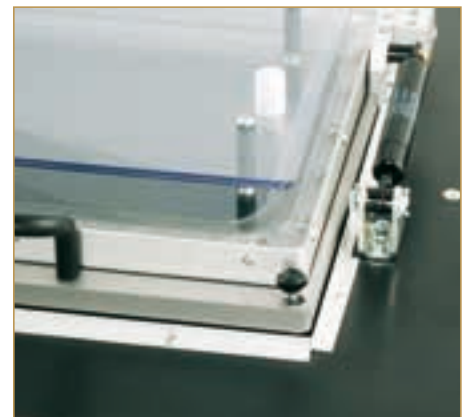

ZSK 2040-ADP closed

Customizing Accessories*

Matching Accessories for self-customizing of the INGUN Test Fixtures from page 57 to page 61.
Technical changes possible without prior notification.

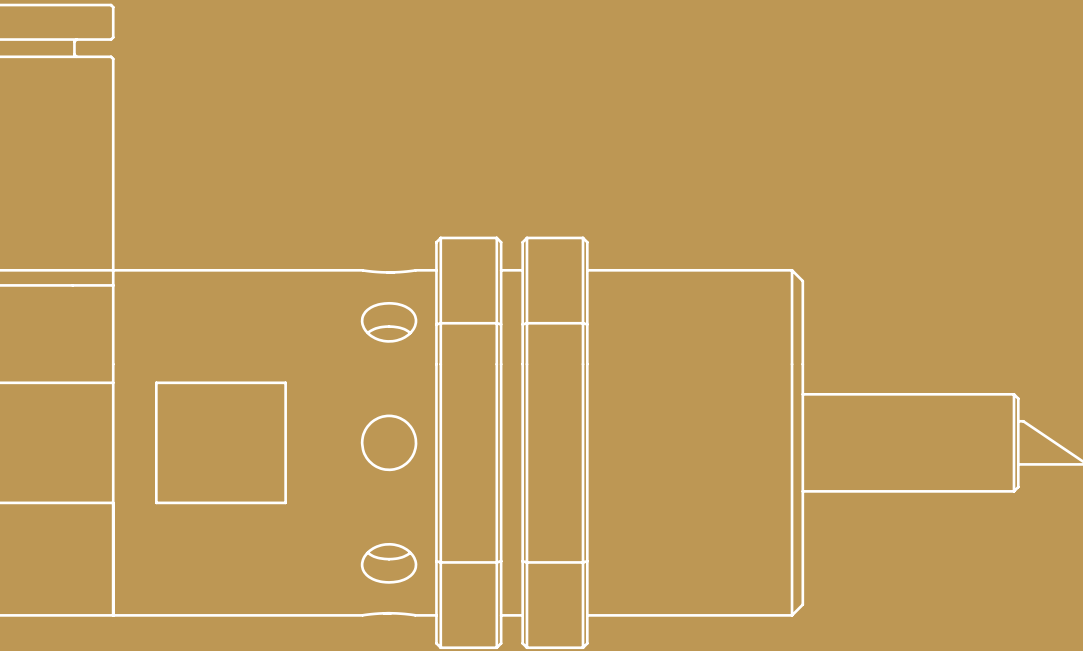

Accessories *	Marking Units	Page	57
	Screwing Units for Potentiometer Adjustment	Page	57
	Pylon-Receiver	Page	58
	Interface Blocks	Page	58
	RJ- and USB-Test Plugs	Page	59
	Tooling Pins	Page	59
	Pushrods	Page	59
	Connector Approach Mechanism	Page	60
	Counter-pressure Springs	Page	60
	Contact Cleaning Mats	Page	60
	Pre-registration Pins	Page	60
	PCB Support Disks	Page	60
	Stroke limiting Disks	Page	60
	Vacuum-free Zone	Page	61
	Transfer Field	Page	61

* Excerpt

Customizing Accessories (Excerpt)

To enable your own customizing of INGUN Fixtures we supply the matching accessories. In the following is a choice of components from our extensive Accessories catalog. Ask for this catalog as well as our Test Probes and RF-Probes catalogs. Alternatively you can download the catalogs from our homepage.

Marking Units

The INGUN Marking Units excel themselves with their sturdiness, compact size, simple assembly and their long-life. We offer various types to support all Fixture designs and concepts. Please note that the Engraver must be mounted vertical to the surface which is to be marked.

Electric-driven Marking Units

Part No. 24447 Marking Unit-short with scratching Engraver, Ø 12 × 60 mm (SW 14), 12 V, Ø Circle 2 mm, Marking of hard surfaces (e.g. FR4, CEM1, etc.)



Marking

Part No. 25251 Marking Unit-short with cutting Engraver Ø 12 × 60 mm (SW 14), 12 V, Ø Circle 2 mm, Marking of soft surfaces (e.g. labels, hardwood, etc.)



Marking

Part No. 24456 Marking Unit-long with scratching Engraver, Ø 12 × 100 mm (SW 14), 12 V, Ø Circle 2 mm, Marking of hard surfaces (e.g. FR4, CEM1, etc.)



Marking



Marking Unit-short
(Part No. 24447)



Marking Unit-short
(Part No. 25251)



Marking Unit-long
(Part No. 24456)



Potentiometer
Screwing Unit
(flexible Shaft)
(Part No. 29292)



Manual Screwing
Unit
(Part No. 17049)



Manual Key/Button
activation
(Part No. 19637)



Marking Unit
(Part No. 25241)

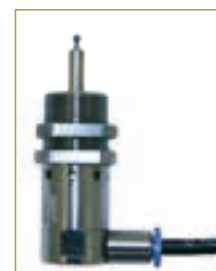

Marking Unit
(Part No. 29483)

Pneumatic-driven Marking Units

Part No. 25241 Marking Unit with cutting Engraver Ø 16 × 57 mm (SW 19), 0.6 MPa, Ø Circle 2 mm, Marking of hard surfaces (e.g. FR4, CEM1, etc.)



Marking

Part No. 29483 Marking Unit with milling Engraver Ø 16 × 57 mm (SW 19), 0.6 MPa, Ø Circle area with approx. Ø 1.0 to Ø 2.0 mm, Marking of hard and soft surfaces



Marking

Screwing Units for Potentiometer Adjustment

The compact, manual or automatic-driven, Screwing Units enables potentiometer adjustment. The automatic Screwing Unit is driven by means of a flexible shaft, which allows an individual and compact mounting of the drive engine. The threaded section and the mounting holes in the housing enables multiple assembly possibilities in the Test Fixture. The automatic Screwing Unit is designed modularly – offering problem-free adaption of the Unit in regard to the various insertable tips and the special customer demands. The insertable tip itself is spring-loaded bedded.

Potentiometer Screwing Unit

Part No. 29292 Potentiometer Screwing Unit (flexible Shaft) with slotted and cross-slotted Screwing Head, Flexible Shaft (Ø 1.8 mm, L ≈ 1 m), Retaining Ring 4 × 0.4 (DIN 471) and Hexagon Screwing Tool SW0.9

Part No. 17049 Manual Potentiometer Screwing Unit, vacuum-tight, with slotted and cross-slotted Screwing Head

Part No. 40850 Manual Potentiometer Screwing Unit with slotted Screwing Head

Manual Key/Button activation

Part No. 19637 Manual Key/Button activation

Pylon Receiver

The Pylon Receiver from INGUN can be loaded with all INGUN Interface Blocks.



Part No. 32162
INGUN Pylon-Receiver (10 Interface Blocks) with extended contacting stroke (Further information see on page 47)

Interface Blocks

Interface Blocks, loaded with INGUN Test Probes, guarantee best contacting quality and low contact resistance. The INGUN Interface Blocks are used in the Intermediate Interfaces of the INGUN Interchangeable Fixture Kits (e.g. MA 21xx-Series) as well as in external Interfaces (e.g. Rohde&Schwarz, TestStation GR). The Working space is 15.1 ± 0.5 mm.

High-frequency Block 16-pole (2 GHz)



SB-T-HF-016-2GHz-Z
Part No. 34581
 Loaded with: HFS-810 305 051 A 5306

SB-P-HF-016-4GHz-Z
Part No. 34571
 Loaded with: SB-810 Z
 Centering: $\pm 0,3$ mm

High-frequency Block 16-pole (4 GHz)



SB-T-HF-016-4GHz-Z
Part No. 34996
 Loaded with: HFS-840 305 051 A 5306

SB-P-HF-016-4GHz-Z
Part No. 34571
 Loaded with: SB-810 Z
 Centering: $\pm 0,3$ mm

Our Radio-frequency Blocks are designed to take up to 16 transfer contacts and can be ordered according to the present requirements from 1 to max. 16 x loaded. The loading position of the partly-loaded RF-Blocks are freely selectable. For further information see our Product Flyer INGUN Interface Blocks – Reliable Connections.

Signal Block 170-pole (4 A)



SB-T-SI-170-4A
Part No. 27616
 Loaded with: GKS-945 357 106 A 1100

SB-P-SI-170-4A-0,6
Part No. 13515
 Loaded with: KT-158 06

Signal Block 170-pole (4 A) Low Ohm



SB-T-SI-170-4A-N
Part No. 31006
 Loaded with: HSS-118 317 175 A 1102

SB-P-SI-170-4A-0,6
Part No. 13515
 Loaded with: KT-158 06

Optical wave-guide Block 45-pole



SB-T-LL-045-DA2,3-S
Part No. 27618
 Loaded with: KS-004 35 G-K
 Without: LWL (Part No. 39910)

SB-P-LL-045-DA2,3
Part No. 29448
 Loaded with: KS-004 35 G-K
 Without: LWL (Part No. 39910)

Optical wave-guide Block 20-pole for Feasa OH-3

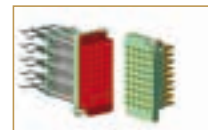

SB-T-LL-020-OH3-S
Part No. 38696
 Not loaded, loadable with e.g.: 20x Feasa OH-3 (Part No. 33685)

SB-P-LL-045-DA2,3
Part No. 29448
 Loaded with: KS-004 35 G-K
 Without: LWL (Part No. 39910)

High-current Block 24-pole (24 A)



SB-T-HS-024-24A
Part No. 27628
 Loaded with: HSS-120 317 300 A 2202 M

SB-P-HS-024-24A-1,0
Part No. 27620
 Loaded with: KT-120 L3 E02-30

High-current Block 2-pole (50 A)



SB-T-HS-002-50A
Part No. 31549
 Loaded with: HSS-150 317 300 A 5002 M

SB-P-HS-002-50A-1,0
Part No. 31550
 Loaded with: KT-150 L3 E03-M3

Pneumatic Block 8-pole RC-block self closing



SB-T-PN-008-PK3-A
Part No. 37820
 Loaded with: Connector female (Part No. 37819)

SB-P-PN-008-PK3-A
Part No. 37821
 Loaded with: Connector male (Part No. 37818)

For further Interface Blocks see our Product Flyer INGUN Interface Blocks – Reliable Connections.



Contacting of RJ- and USB-Plugsockets

For the wear-free contacting of RJ-and USB-Plugsockets INGUN offers especially manufactured mating parts, which are designed with robust copper-beryllium wires.



For Tooling Pin Holes:

Ø 2.0 mm to Ø 3.5 mm

Part No. 24481 conical-shaped
Part No. 25214 dagger-shaped
Tooling Pin Ø 3.98 mm

For Tooling Pin Holes:

Ø 3.5 to 5.5 mm

Part No. 25215 conical-shaped
Part No. 25217 dagger-shaped
Tooling Pin Ø 5.98 mm

RJ-Test Plugs

Spring-loaded Tooling Pin Set
(Dagger- and Cone-shaped)

Further special Tooling Pins are available such as e.g. with a disk or for In-line Systems (e.g. with optical safety check or spring-loaded).

RJ-Test Plugs

Part No. 17824	RJ-10 Test Plug, 4-pole
Part No. 17825	RJ-12 Test Plug, 6-pole
Part No. 17826	RJ-45 Test Plug, 8-pole
Part No. 17827	RJ-48 Test Plug, 10-pole

USB-Test Plugs

Part No. 17829	USB-Test Plug, 4-pole, type B
Part No. 21071	USB-Test Plug, 4-pole, type A
Part No. 21072	USB-Test Plug Mini, 5-pole, type B
Part No. 34816	USB-Test Plug Micro, 5-pole, type B

Mounting Shoes are available for the assembly of all Test Plugs.

Pushrods



A large range of Pushrods is available to support all Pressure Frame Units and Cover systems. Furthermore the range of Pushrods also takes the various PCB thicknesses into consideration.

Pushrods

Pushrods for Manual Test Fixtures

Part No. 19813	Pushrod, length 51 mm, Head Ø 2.5 mm ⁽¹⁾
Part No. 19815	Pushrod, length 51 mm, Head Ø 6.0 mm ⁽¹⁾
Part No. 21615	Pushrod, length 60 mm, Head Ø 2.5 mm ⁽²⁾
Part No. 23190	Pushrod, length 60 mm, Head Ø 4.0 mm ⁽²⁾
Part No. 18870	Pushrod, length 60 mm, Head Ø 6.0 mm ⁽²⁾

Pushrods for Vacuum Test Fixtures

Part No. 17324	Pushrod, length 55.6 mm, green, Head Ø 2.5 mm
Part No. 19419	Pushrod, length 55.6 mm, green, Head Ø 6.0 mm

Tooling Pins

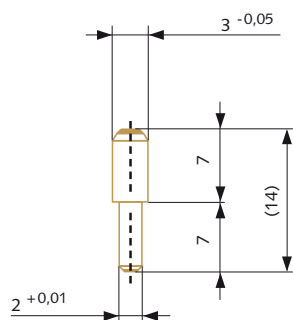

Rigid Tooling Pins

The Tooling Pins from INGUN register the PC-Board in the applicable Tooling Pin Holes and guarantee an exact placement of the PC-Board on the Fixture. Tooling Pin diameters from 1.9 to 5 mm in steps of 0.1 mm are available. The Tooling Pins have a tolerance of -0.05 mm.

Spring-loaded Tooling Pins GFS-874

To enable high-precision customizing INGUN also offers spring-loaded Tooling Pins. In this case the PC-Board sits on a conically shaped Tooling Pin Plunger. A Tooling Pin set is necessary for customizing. This set consists of one Tooling Pin with a conical-tip and one with a dagger-tip.

⁽¹⁾ e.g. for KTE 130/KTE 135/KTE 2130/KTE 2135/PA 2130/PAZ 200

⁽²⁾ e.g. for ATS 21xx



*SAM-Mini Manual
(Part No. 31944)*

Connector Approach Mechanisms

Approach Mechanisms offer the possibility to contact connectors from the side. They can be additionally built into a Fixture and are favoured for wear-free contacting of connectors. Manually or automatically driven versions are available.

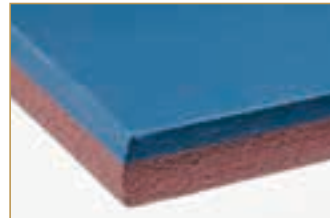

Cleaning Mat

Cleaning Mats

PC-Boards often show signs of flux deposits and oxide layers, which contaminate the surface and create an insulating layer. With the increased usage of the Test Probes the deposits are transferred to the tips of the

Test Probes. INGUN proposes cleaning the tips of the Probes with a Cleaning Mat. Cleaning is recommended for those tip-styles with selfcleaning features, e.g. 01, 09, 15, 31, 38, 77, 91, 93, 97, 98. Contact Cleaning Mats can be used on all INGUN Test Fixtures without Pressure Frames and are available in various sizes.

Further details – also in regard to Cleaning Brushes – can be found on the applicable Product Data Sheets.

Part No. 31944	SAM-Mini Manual (Contacting Stroke-10) Outside Dimensions: 62 × 37 × 40 mm (w × d × h)
Part No. 12306	SAM-E Manual (Contacting Stroke-14) Outside Dimensions: 200 × 145 × 85 mm (w × d × h)
Part No. 12559	SAM-DE Manual (Contacting Stroke-14) Outside Dimensions: 270 × 145 × 85 mm (w × d × h)
Part No. 29233	Sam-Mini Automatic (Contacting Stroke-7)* Outside Dimensions: 30 × 65 × 20 mm (w × d × h)

* at a parallel stroke of the ATS with 7 mm

Part No. 3254	KRM 01; Outside Dimensions: 250 × 100 mm
Part No. 3255	KRM 02; Outside Dimensions: 250 × 200 mm
Part No. 3256	KRM 03; Outside Dimensions: 250 × 300 mm
Part No. 8460	KRM 04; Outside Dimensions: 700 × 500 mm

Further sizes on request.

Pre-registration Pin

Part No. 13781	Pre-registration Pin Ø 12 × 22 mm (d × h)
Part No. 42295	Eccentric Pre-registration Pin Ø 12 × 22 mm (d × h)

Counter-pressure Springs

Part No. 2785	FED 10/80/15.0
Part No. 23818	FED 10/85/21.5 dual stage Fixtures
Part No. 1571	FED 10/90/16 Customizing VA 2030/2040
Part No. 1572	FED 14/80/22 dual stage Fixtures
Part No. 1569	FED 14/90/17.5
Part No. 1584	FED 11,6/74/26 Counter-pressure Spring for spring-loaded Mounting Plate for Manual Fixtures MA

PCB Support Disk

Part No. 3161	PCB Support Disk (anti-static) Ø 5 × 2.8 mm (d × h)
----------------------	--

Stroke limiting Disk

Part No. 2579	Stroke limiting Disk for assembly on Probe Plate of Vacuum Test Fixtures; Ø 10 × 1 mm (d × h)
----------------------	--

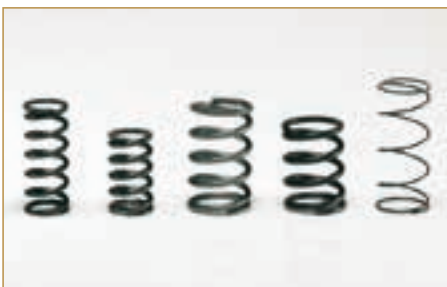

Counter-pressure Springs



Pre-registration Pin



Eccentric Pre-registration Pin



PCB Support Disk



Stroke limiting Disk

ESD-KITs (for single-stage Test Fixtures)

Part No. 4137 ESD-KIT for ADPs with 8 mm height (suitable for the most VA Test Fixtures)

Part No. 41899 ESD-KIT for ADPs with 4 mm height (suitable for the most MA Test Fixtures)



ESD-KIT
(Part No. 4137)



ESD-KIT
(Part No. 41899)

Vacuum-free Zone

For customizing with Vacuum-free Zones INGUN offers tailor-made sizes – both for single- and dual-stage customizing.

Part No. 000512 Vacuum-free Zone made of silicone (single-stage); variable, manufacturing dimensions according to customer demands. (Outside Dimensions of PCB)

Part No. 000513 Vacuum-free Zone made of silicone (dual-stage); variable, manufacturing dimensions according to customer demands. (Outside Dimensions of PCB)

Transfer Field

The following contacting components are used in a Transfer Field. Note: The rigid Contact Terminals are normally mounted in the Pressure Frame Unit.

Contact Transfer in Transfer Field

KT-254 W3 E12 Contact Terminal with wire-wrap connection for Transfer field (usage in upper Probe Plate)

KT-112 143 215 E02 Contact Terminal variant with exchangeable KT (usage in Receptacle KS 112 47)

GKS-100 307 150 A 1500 Spring-loaded Test Probe for Transfer Contact (assembly in Receptacle)

KS-100 47 Receptacle with wire-wrap connection for Transfer Contact (usage in lower Probe Plate)

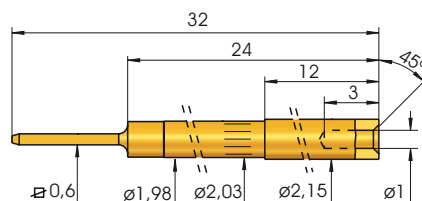

KT-254 W3 E12

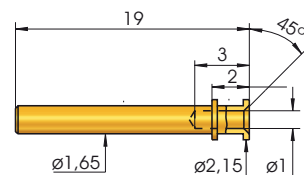

KT-112 143 215 E02



Seal made of silicone

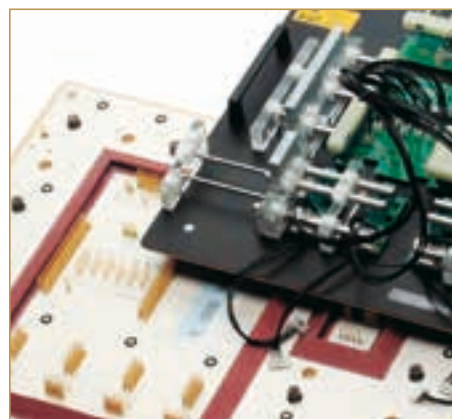

Vacuum Test Fixtures with vacuum-free zone



Special Test Fixtures

On the following pages you will find some highlights of our customized Test Fixtures. Please confirm your testing requirements – we'll be pleased to offer you the ideal testing solution.

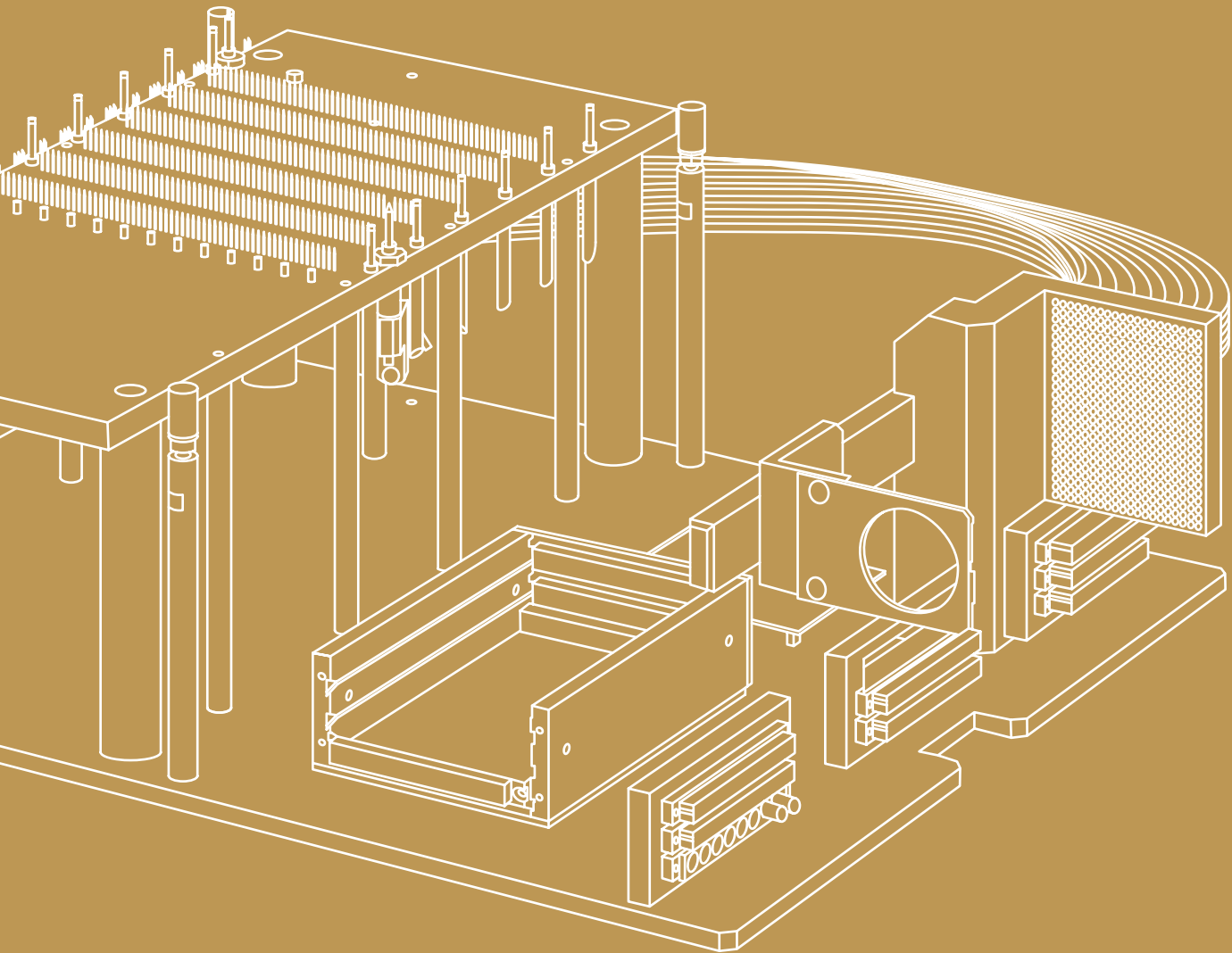

Manual Interchangeable Fixture MA 2110 with TTI-Testron Interface	Page	63
Manual Test Fixture MA 2110 with tall housing and ATS 2110	Page	64
Manual Test Fixture MA 2135/D/H with ZSK Unit (top-side contacting)	Page	65
Probe Plate Unit for the manual Interchangeable Test Fixture MA 2135	Page	66
Pneumatic Fixture with gear-wheel drive and hyperbolic Intermediate Interface	Page	67
Compact Special Contacting Unit	Page	68
Radio-frequency Fixture based on MA 2135	Page	69
Vacuum Test Fixture VA 2040/F/H/Pylon incl. Receiver	Page	70
Vacuum Test Fixture VA 2501-2/E/TD88xx-S	Page	71
Vacuum Interchangeable Kit ATS 423 for VIN 423	Page	72
Replacement Kit ATS 423 for Vacuum Interchangeable Test Fixture VIN 423	Page	73
Approach Mechanisms on Interchangeable Plate for Climatic Cabinet Test	Page	74
Contacting Head for Automotive Combi-Instrument	Page	75
Interchangeable Kit for Inline-System	Page	76

Manual Interchangeable Fixture of MA 21xx-series with TTI-Testron Interface

The testing demand as per specification:

Contacting a connector from three sides is required. Contacting of two connectors is necessary from above and below and then furthermore contacting of an 8-channel Mini Western Connector from the side. The PC-Board is already built into the housing.



Customized Interface



The realization:

A special mating Plug, loaded with copper-beryllium wires, was manufactured extra for the task of contacting the Mini Western Connector. This mating Plug is floatingly mounted on the contact block and is activated via a pneumatic linear slide.

When the Pressure Frame is closed, the Test Probes in the upper Probe Plate move parallel towards the connectors. The upper Probe Plate and the lower Probe Plate, which has the UUT mounted on it, are aligned to each other by means of guide pins and bushes.

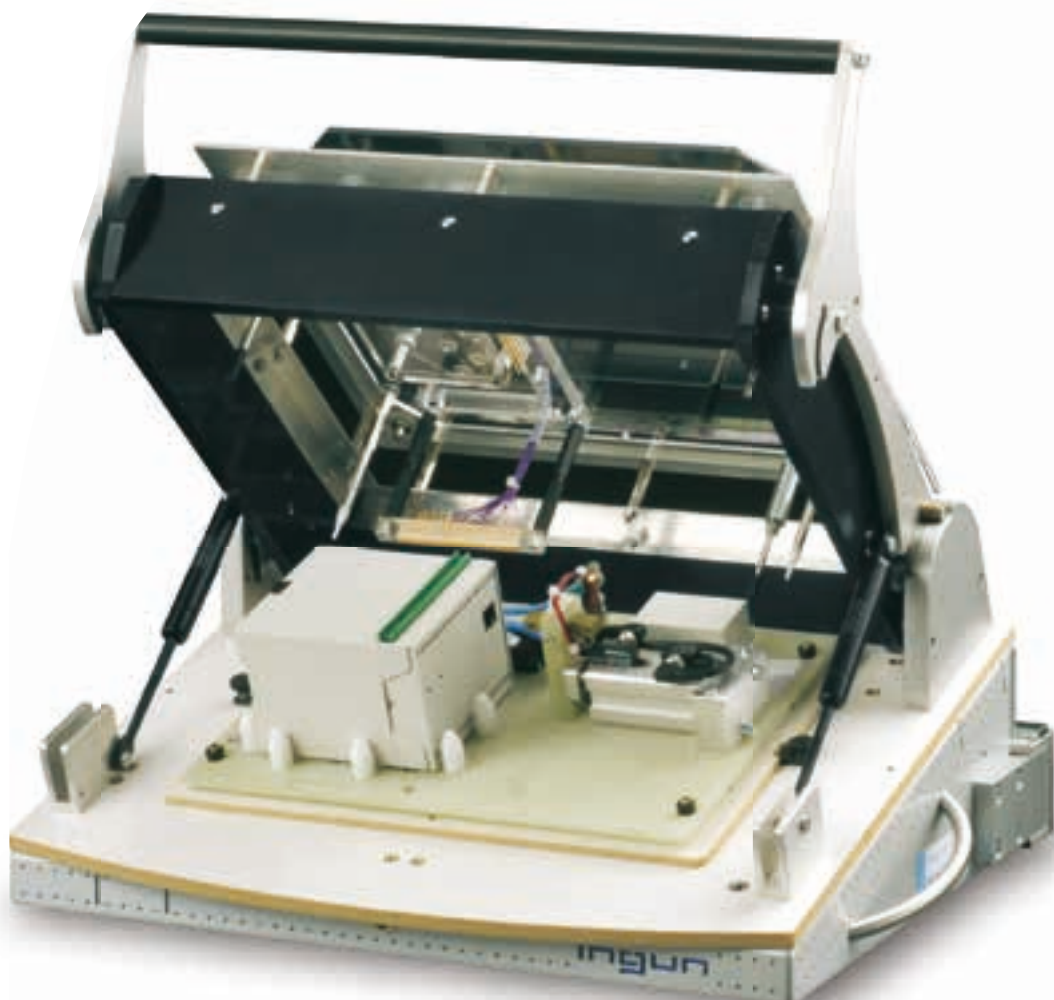

Manual Test Fixture of MA 21xx-series with tall housing

The testing demand as per specification:

The UUT (Unit under Test) consists of a PC-Mainboard and three further PC-Boards which are connected to it with ribbon cables. An SMD micro switch, which is assembled on the upper side of the PC-Board, must be activated automatically. All four PC-Boards must be contacted at the same time. Three servomotors guide sensors towards three PC-Boards. The sensors must be approached very precisely. Three additional electronic circuitries must be assembled on the under side of the Probe Plate.

The realization:

A MA 21xx Test Fixture with a tall housing was chosen, so that the extensive additional electronic circuitries on the under side of the probe plate have sufficient space. The three PC-Boards are positioned via the contour and the PC-Mainboard in the middle via tooling pins. In addition, removal-troughs are milled into the spring-loaded Mounting Plate. Three round cut-outs in the Top Plate and the Probe Plate allow the swinging in of the sensors towards the PC-Board. The micro switch is activated by means of a lifting solenoid, which is assembled in the Pressure Frame Unit.

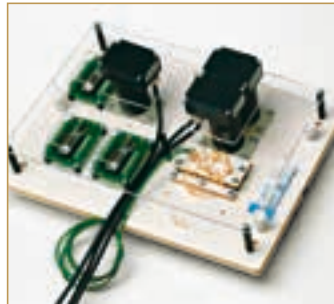

Manuel Test Fixture MA 2135/D/H with ZSK Unit (for contacting from above)

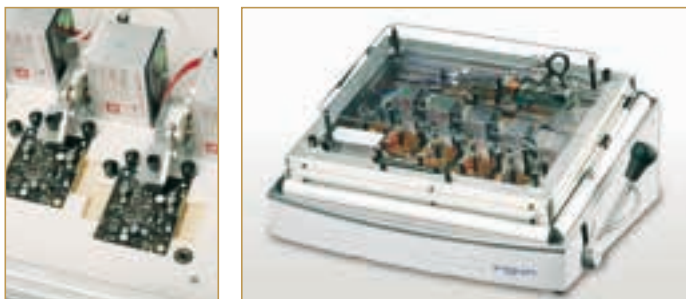

"Good" marking with symbol and color

The testing demand as per specification:

The testing demand requires contacting the PC-Board with Test Probes. The subsequent "good" marking must be applied on the same side. The functionality of the LEDs on the PC-Board is to be tested via sensors. To allow the Manual Fixture to be used for a number of projects, the concept should choose an Interchangeable Fixture Kit design.

The realization:

The PC-Boards are placed on the Fixture with the Test Pads on the topside. The PC-Boards are marked with a color and a symbol after successful testing. Because the stamp cushion of the Marking Unit can only be stored horizontally, contacting of the PC-Board must also be done from above.

The contacting from above (ZSK-Unit) with the Test Probes and the LED-Test is float-mounted to the Pressure Frame Plate. During contacting the ZSK Unit is precisely registered via guide pins in the upper Probe Plate and matching guide bushes in the lower Probe Plate. At the same time the Optical Beam Waveguides, which are let into in a black plastic tube, are approached. The Optical Beam Waveguides are guided into the evaluation electronic, which is assembled on the anti-static Pressure Frame Plate.

The transfer field between the Pressure Frame Plate and the Probe Plate transmits the electronic signals onto the Intermediate Interface inside the Interchangeable Kit to 96-way connectors.



Probe Plate Unit for the manual Interchangeable Test Fixture MA 2135

The testing demand as per specification:

Three approach mechanisms are to contact three different connectors directly, which are assembled on a PC-Board. These three connectors are positioned in different directions. Neither electronics nor pneumatics is available for the drive units. The connectors can be contacted at the same time as well as the PC-Board from below via the probe field.

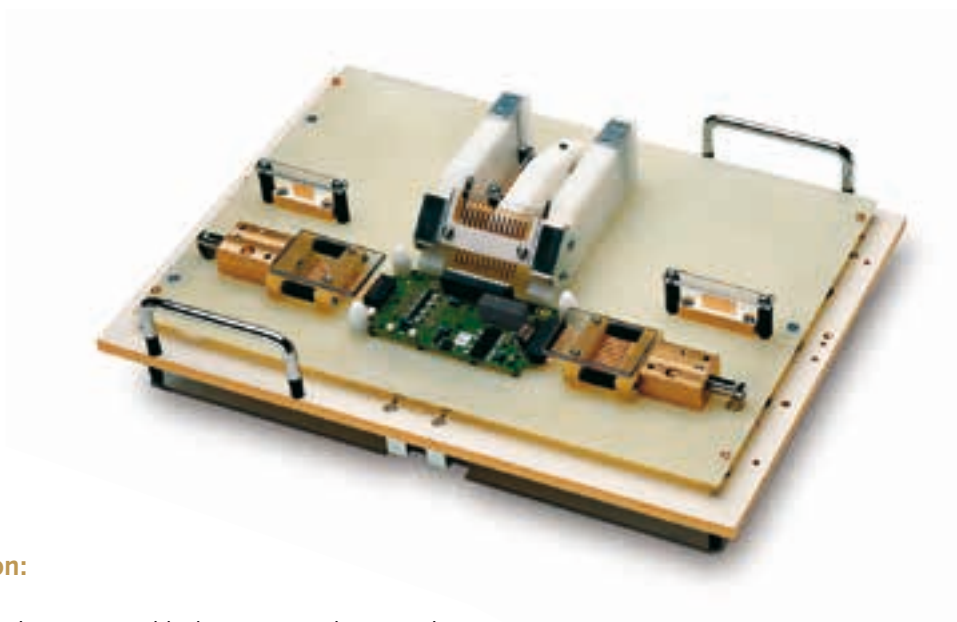
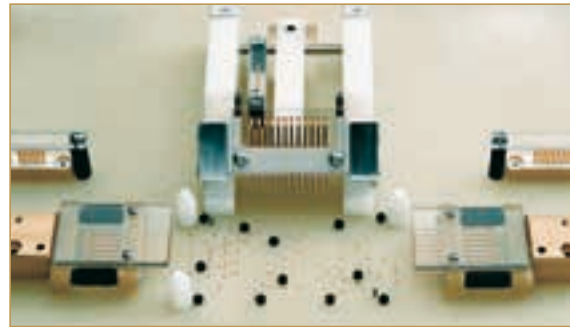

The realization:

The drive to the three contact blocks was carried out via three inclines. By simple use of a mechanical hand-lever, four contacting levels within a compact space, enable contact to the PC-Board. Two transfer fields transfer the contacts of the approach mechanisms inside the Test Fixture to the Interface.

Pneumatic Fixture with gear-wheel drive and hyperbolic Intermediate Interface

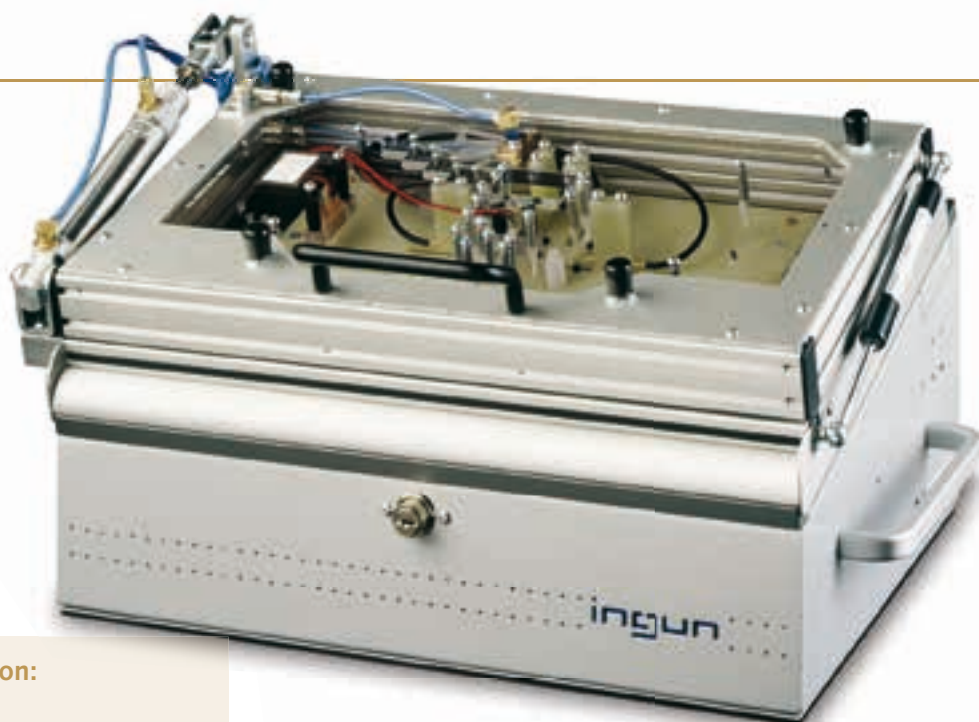

The testing demand as per specification:

The Test Fixture is to be driven pneumatically and the Pressure Frame must open by itself. Four pushbuttons on the UUT must be activated automatically. Numerous special connectors are to be assembled in the back panel of the Fixture. The back panel also serves as the Interface to the external measurement instruments.

Additional PC-Boards, switch boxes and intermediate connectors must be integrated inside the housing.

The contacting unit is to be designed as an Interchangeable Unit. When doing this, special emphasis must be put on an Intermediate Interface with a low impedance. The operating pushbuttons must be controlled individually.

The realization:

A standard Pneumatic gear-wheel Fixture (series PAZ 100) was enhanced with a hyperbolic Intermediate Interface, self-opening Pressure Frame Unit as well as a taller housing. The hyperbolic Intermediate Interface excels itself with a very low contact resistance ($\leq 2 \text{ m}\Omega$), which is achieved with a flexible spring bush that lays itself around the mating pin. Over 100,000 plug-in cycles are possible.

The interface can be easily latched and unlatched by means of a toggle lever system.

The pushbuttons are activated by means of four pneumatic probes, which are assembled in the interchangeable Pressure Frame Plate, and can be individually controlled via micro valves.

To accommodate the numerous additional components inside the fixture housing a special 60 mm taller housing was chosen. A further special feature of the Interface is also the hyperbolic RF-contacts, which can transfer up to 3 GHz.



Details of drive unit and view of Intermediate Interface



Interchangeable Kit

Compact Special Contacting Unit



Mounting for PC-Board

The testing demand as per specification:

12 PC-Boards are to be contacted simultaneously inside a specific housing size. The PCBs can be precisely registered via tooling pins.

The drive should be carried out via a mechanical hand lever. The materials used must be heat proof up to approx. 120°C, because the closed box is used inside a climatic cabinet. To ensure that the PCBs being contacted quickly absorb and take on the ambient temperature of the climatic cabinet, it is important that the volume of material used for manufacturing the drive unit and the PCB mounting is kept as little as possible. This will guarantee that the temperature of the PCBs is quickly brought into line with the constantly changing testing temperature.

The realization:

During the concept and design phase special attention was given to ideal fitting conditions, because with every additionally used PC-Board the through-put quantity during burn-in is increased.

By means of a central hand lever, which subsequently activates a toggle lever, all UUTs are contacted at the same time. The PC-Boards are set one after the other in two rows of six PCBs.

Contacting is done with Test Probes. The UUTs are mounted on spacer pins, which at the end have the matching tooling pin diameter and therefore provide precise registration. The drive mechanism is mounted in a rigid frame made of aluminum profile. The Probe Plate for the Test Probes is made of heatproof and robust glass fiber FR4 material.

Radio-frequency Test Fixture based on MA 2135



Details of RF shielding

The testing demand as per specification:

A PC-Board, which reacts very sensitively to electro-magnetic noise influences must be tested. Therefore, the UUT must be completely shielded to the outside, both for the measurement as well as to protect the operator. The signals, which must be measured on the PC-Board, must be passed from the inside of the RF-cover through to the outside. The necessary attenuation values are to be derived from the specification.



The realization:

A standard mechanical fixture MA 2135 was used as the bases for the customizing. A standard Probe Plate Unit KTE 2135 was used for the mounting the UUT. The size of the copper pressure frame cover is laid down in accordance to the attenuation values, which were calculated by the customer. The Probe Plate Unit was also shielded with a copper cover. The wire connections in the shielded chamber were laid out via special ceramic throughput capacitors, ferrite pearls (for NF-signals and power supply) as well as the coax-connections.

The RF-signals on the PC-Board are transferred to the Test System by means of INGUN RF-Probes. The spring-loaded Probe Mounting Unit has an RF-seal made of flexible copper lamellas. As soon as the Pressure Frame is closed and the Test Probes are contacted by means of a mechanically driven lever, the seal pushes itself over the pressure frame cover from the outside and subsequently provides an RF-seal.

The pushrods are mounted into the Pressure Frame Cover by means of plastic screws.

Vacuum Test Fixture VA 2040/F/H/Pylon incl. Receiver

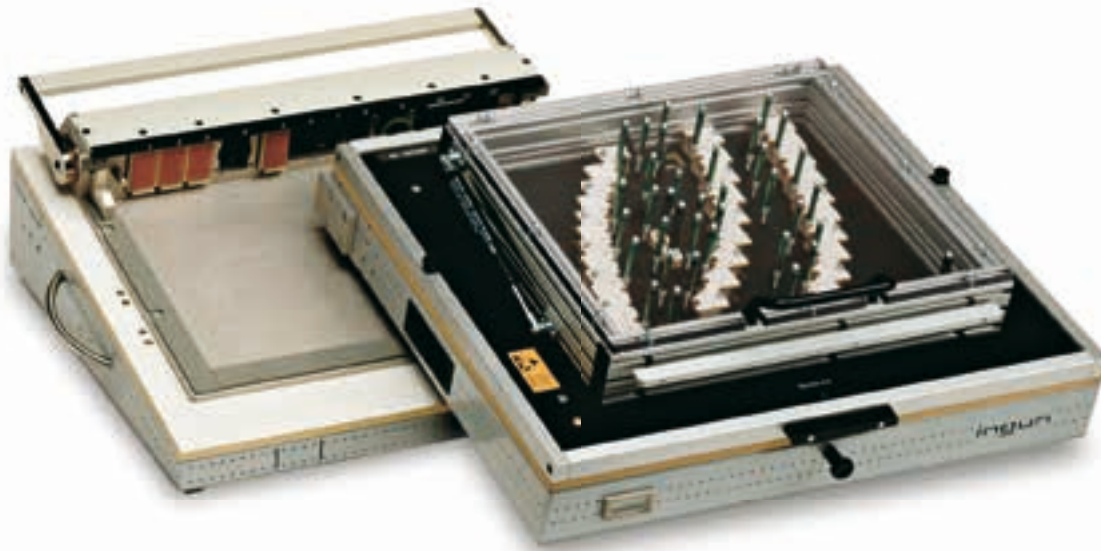

The testing demand as per specification:

The Test Fixture should be activated with vacuum and the three PC-Boards must be contacted and tested when they are connected up together. The connector of the PC-Mainboard in the middle must be contacted with Test Probes and signals must be transferred to the Fixture Interface. LEDs are mounted on the PC-Board, of which both their functionality and their colour must be checked. In addition, the barcode of one of the PC-Boards must be read from below. The PC-Boards must be positioned via the contour and contacted from below using Test Probes.

The realization:

Because the PC-Boards are connected together, the placement location was already clear beforehand. A mounting pocket was milled to secure the 3-way connector, which is connected to the PC-Mainboard via a wire connection and which needs to be contacted. To check the LEDs, chambers were installed on the side of the PC-Board, which are opened towards the LEDs. Subsequently the sensor with the applicable evaluation electronic was soldered directly onto a connector strip and assembled in these chambers and pointed towards the LEDs. The connector pins are contacted directly from below with Test Probes, which are mounted in the Probe Plate. Anti-static guide pins define the exact location of the PC-Board via the outline.

The Test Fixture was designed with a vacuum-free zone and a Pressure Frame. This allows a cut-out in the Top Plate and the Probe Plate underneath the position of the barcode on the PC-Board, as well as the problem-free assembly of the connector with the evaluation electronic. The basic Test Fixture unit is equipped with a Pylon Interface. This external Intermediate Interface can be connected both mechanically and electrically by means of a Pylon-Receiver mounted on a flat housing. In the case of this special project, the Pylon Interface was assembled with two 170-pole signal blocks. On request, optical waveguides, high-current and radio-frequency probes as well as pneumatic blocks can be assembled (see accessories pages 42–46).

Vacuum Test Fixture VA 2501-2/E/TD88xx-S

The testing demand as per specification:

Two different contacting stages are necessary for the combined ICT-/FCT-Test. In addition, the Test Probes for contacting the transformer connectors must be separated electro-mechanically for safety reasons.

A pneumatic Pressure Frame catch prevents opening during contacting. The Test Fixture should be as compact as possible. Test Pads with \varnothing 0.5 mm should be contacted reliably.

A side-connector must be contacted with Test Probes.

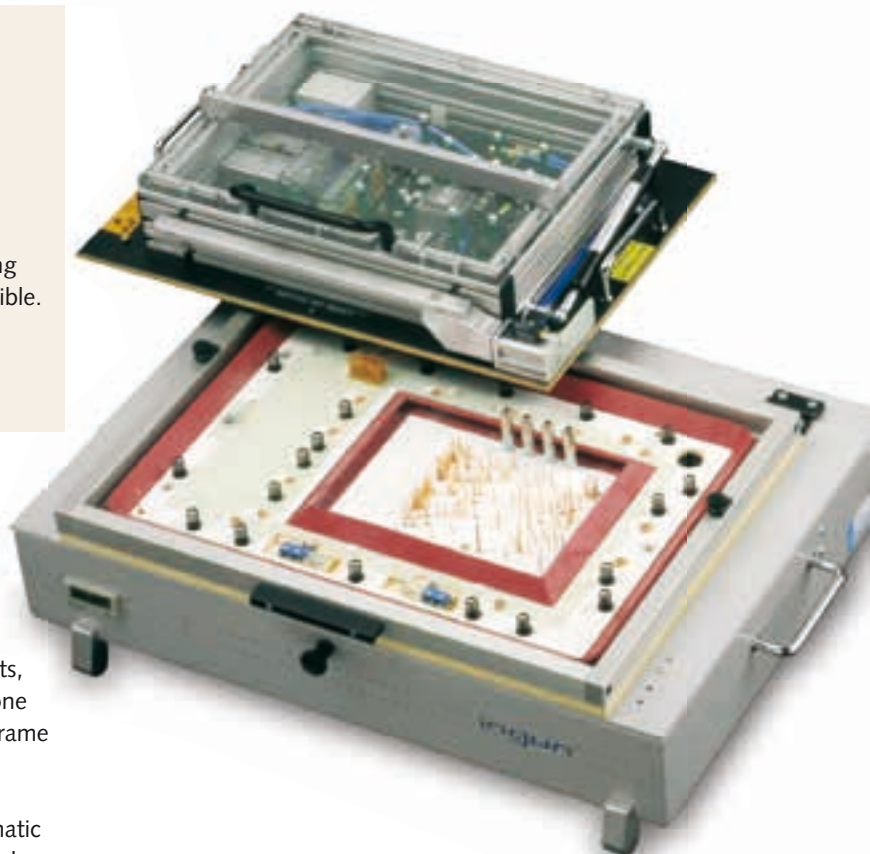

The realization:

A shuttle plate with spacer bolts, which have different heights, allows two different contacting heights. The vacuum-free zone in combination with an additionally strengthened Pressure Frame guarantees the necessary stroke.

A connector approach mechanism is equipped with a pneumatic linear unit, which activates the contacting block. When closed, the Pressure Frame is mechanically blocked by means of a small pneumatic cylinder. The compressed air supply for the pneumatic cylinder is guided directly through the vacuum chamber into the fixture base unit. The electro-mechanical drive of the pneumatics is also transferred down to the Fixture Interface via a Test Probe transfer field. With this, moving wire connections are avoided.

The Fixture housing contains the Intermediate Interface, which can also be separated by means of a pneumatic linear unit.



Compact high-tech customizing

Vacuum Interchangeable Kit ATS 423 for VIN 423

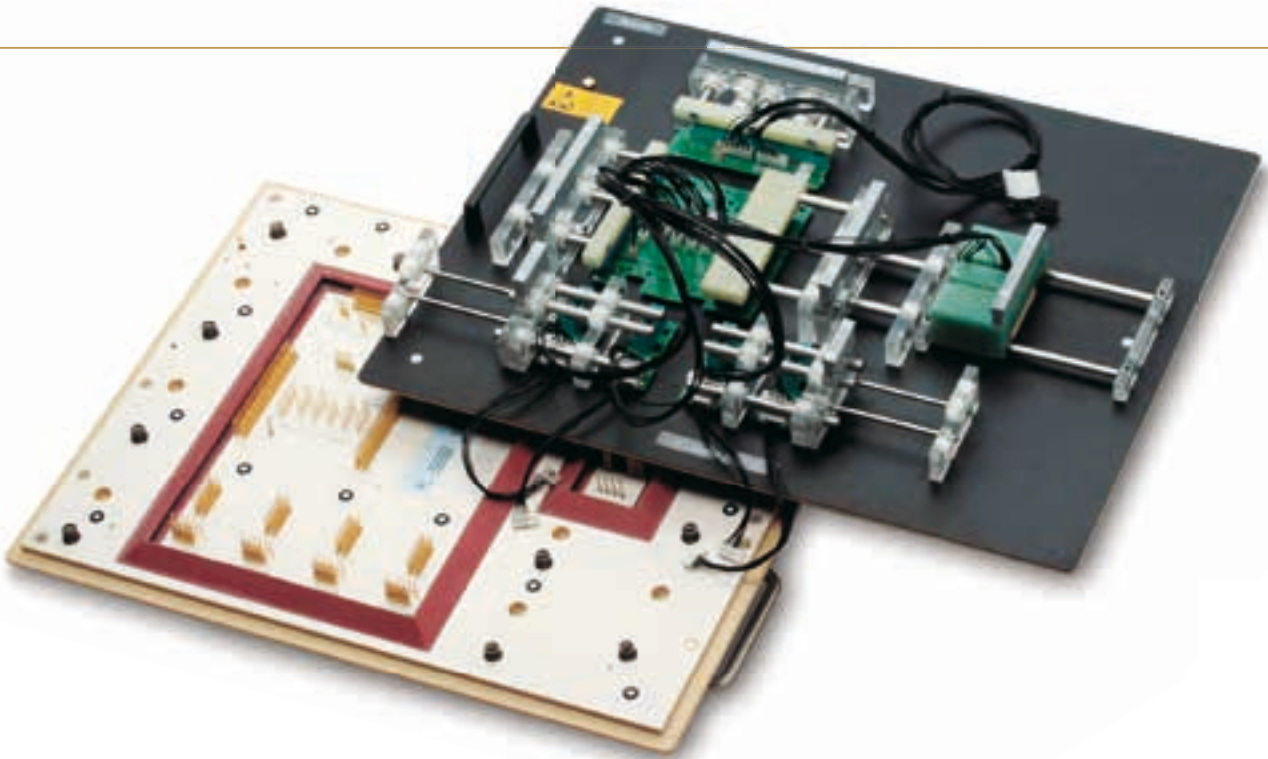

The testing demand as per specification:

A complete PC-Board Unit consisting of 4 individual PC-Boards must be contacted. The contacting is to be done, on the one hand, using the standard fixture probe plate and, on the other hand, via the connectors, which are required for the Functional Test.

The UUT must be accessed from above during contacting, to allow subsequent plugging in of the connectors with the cables.

The connectors connect the individual PCBs together and enable voltage supply during the Functional Test. A vacuum-operated Interchangeable Fixture is required for the INGUN Fixture System VIN 423.

The realization:

A complex Pressure Frame set-up was designed, which positions each PCB individually and secures them against the force of the Test Probes. These Pressure Frame Units are manufactured in such a way that after contacting from below (with the Probe Plate) the connectors, which are also needed for the FCT Test, can be plugged in freely from above.

Furthermore, precise mounting blocks were milled for the connectors, which secure these on the Top Plate. The Test Probes mounted in the Probe Plate contact the connectors. Subsequently, the connectors are connected directly to the Probe Plate and the Test System. The different types of connecting and contacting allow a representative functional test of the PCBs, which are connected together.

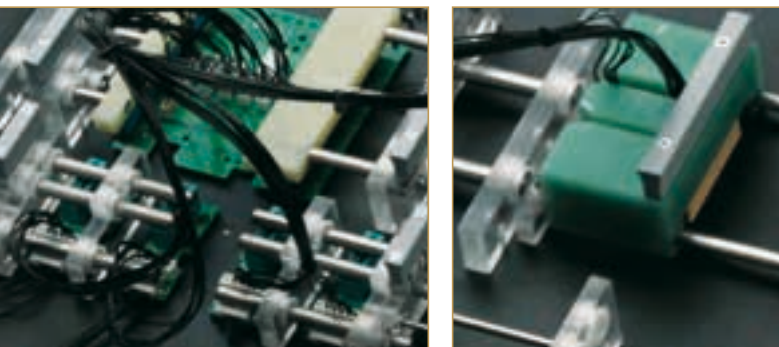

Pressure Frame elements

Replacement Kit ATS 423 for Vacuum Interchangeable Test Fixture VIN 423

The testing demand as per specification:

Three testing locations are required for the functional test. The mounting units for the PC-Boards differ to each other, to be able to carry out three different tests on one and the same Test Fixture. The following demands must be fulfilled: pneumatic activation of key/button, LED-check, contacting of connector clips, automatic potentiometer adjustment as well as checking that the UUT has been placed on the Test Fixture.

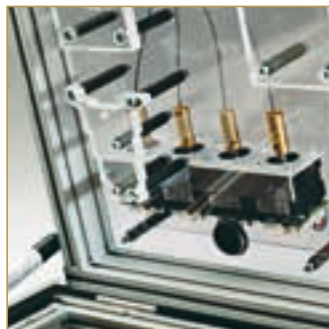

The realization:

In addition to the standard contacting from below, a key/button is activated from the side using a Pneumatic Probe. Optical Beam Waveguides are assembled in a contact block for the LED-check, so that the LEDs mounted on the UUT are as close as possible to the Optical Beam Waveguides. A number of connector clips mounted on the side are also contacted at the same time with Pneumatic Probes and the presence of the screws is checked.

Four potentiometer screwing motors (incl. the applicable control electronics) are assembled on the Pressure Frame Plate inside the Pressure Frame Unit. By positioning the motors on the Pressure Frame Plate and, in combination with flexible shafts, four closely set potentiometers can be automatically adjusted at the same time.

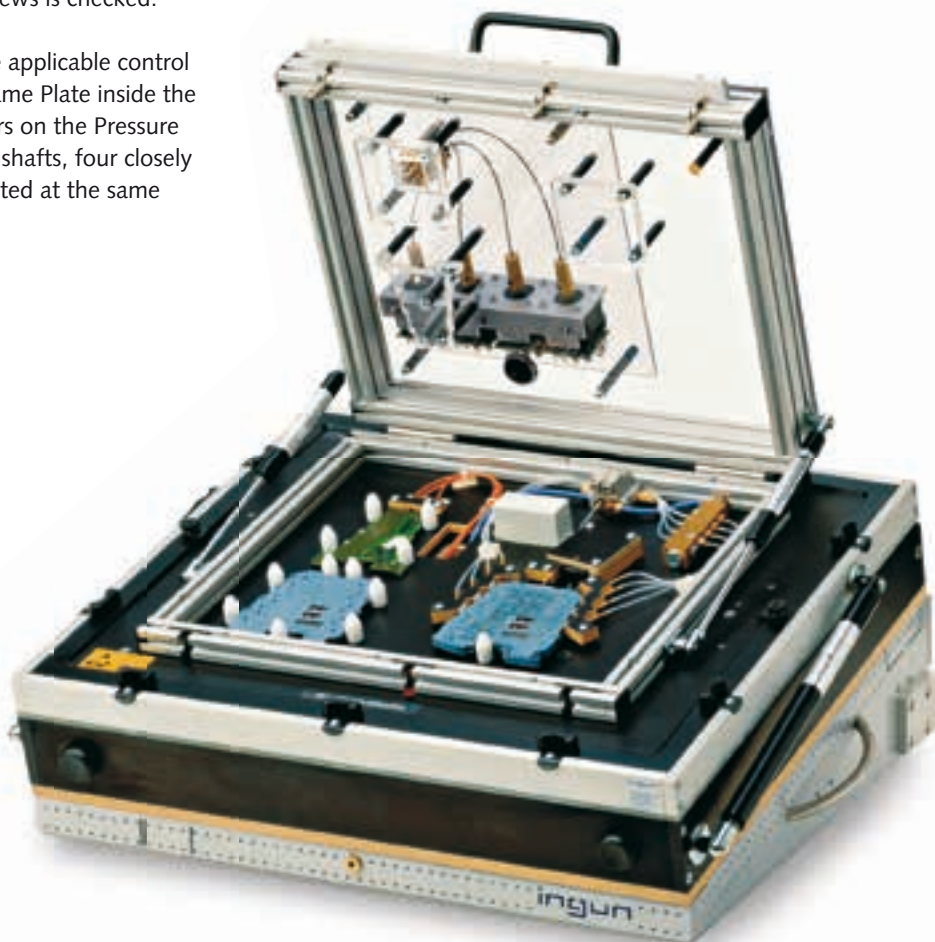

Approach Mechanisms mounted on Interchangeable Kit for tests in a Climatic Cabinet

The testing demand as per specification:

The UUT must be contacted after assembly in the end product. Diverse types of connectors are assembled in the back panel of the housing, i.e. RF-Connectors, LWL-Connectors and Signal-Connectors. The mounting should be designed as an Interchangeable Kit. The Unit will be prone to temperatures of -30 to $+70^{\circ}\text{C}$ during the test. The barcode that is applied to the UUT must be able to be scanned by the operator after placement.

The realization:

Connector Approach Mechanisms, driven with a mechanical hand-lever, move the contact blocks towards the UUTs. The contact blocks are equipped with individual float-mounted contact segments. The pre-registration ensures balancing out of larger positioning tolerances of the connectors, which are to be contacted.

To enable reading the barcode with the hand scanner hard-glass mirrors, which were steamed with silver, were assembled to reflect the barcode and therefore make it accessible to read. One Connector Approach Mechanism works double, and therefore enables simultaneous contacting of two UUTs.

The Interchangeable draw-type Kit has an Intermediate Interface on the rear side.

A solid base-frame made of aluminum profile is placed inside the climatic cabinet and carries the rigid part of the Intermediate Interface. The connection to the Test System is made directly from the Intermediate Interface.

The base-frame is designed in such a way that four Interchangeable draw-type Kits can be used parallel at the same time. Cut-outs have been made in the mounting plates to allow better air circulation.

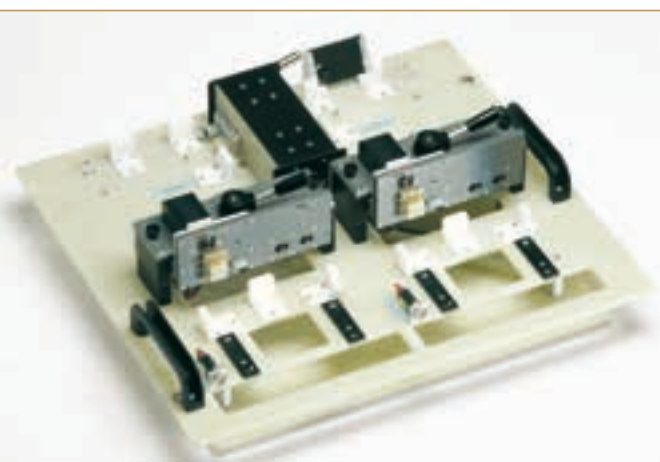

Interchangeable draw-type Kits for the Automotive field

Contacting Head for Automotive Combi-Instrument

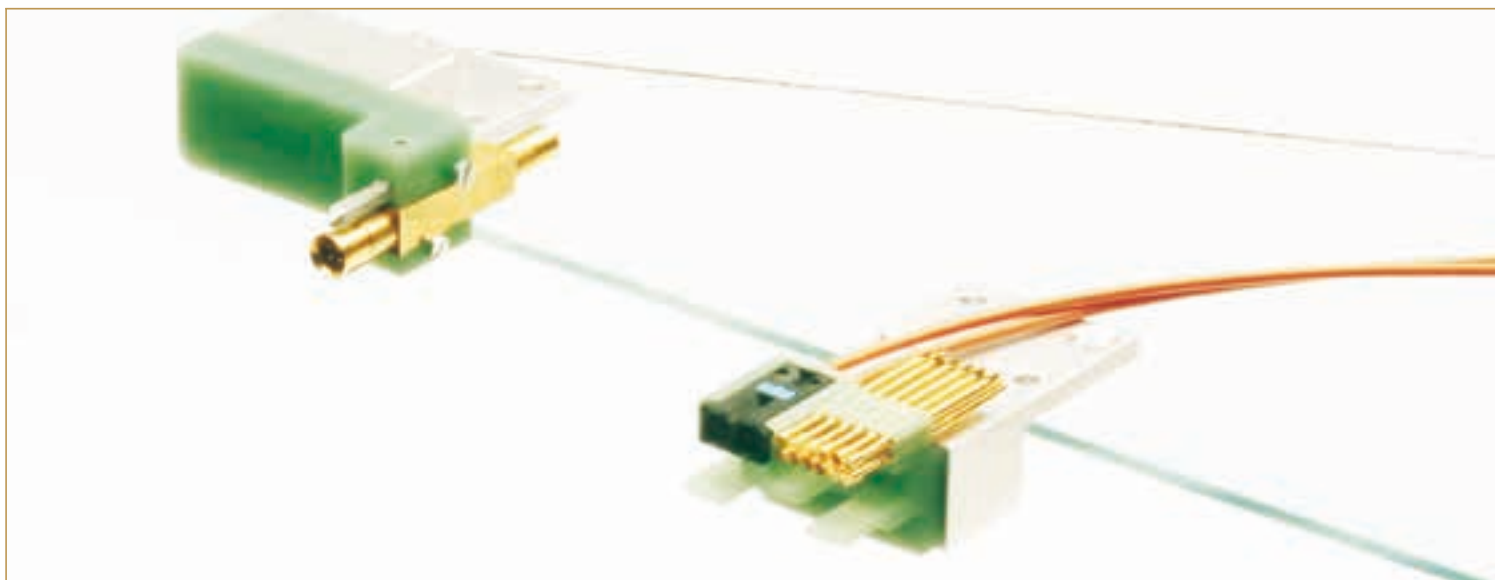

Detail of guide-system for Contact Head

The testing demand as per specification:

Two connectors must be contacted for the Functional Test of an Automotive Combi Instrument. The position tolerance of both connectors to the housing of ± 1.5 mm is unusually large.

The contour of the connector must be pre-registered before actual contacting. This will then ensure that the contact blocks are guided and aligned exactly in regard to the individual connector pins.

Apart from this, Optical Beam Waveguides and RF-signals must be transferred reliably and without loss. The Contact Heads need to be developed by INGUN and will be integrated into an automatic assembly line.

The realization:

To balance out the large positioning tolerances of the connector the mounting had to be manufactured so that it can float considerably. Neutral spring-loaded pressure pieces keep the contacting heads movable in the centre position. Using pre-registration elements the contact head is aligned via the outside contour during approaching of the connector contacts. With this, reliable contacting is guaranteed even in the case of mating connectors, which have been assembled slanted.

The spring hardness of the pressure pieces can be adjusted individually. A special demand presented the new type of 4-way RF-connector. To contact this a new mating RF-connector was developed by INGUN.

One contact block carries the RF-Probe and the other contact block carries two Optical Beam Waveguides for the MOST-Bus as well as the standard Test Probes for contacting the connector pins.

Interchangeable Kit for Inline-System

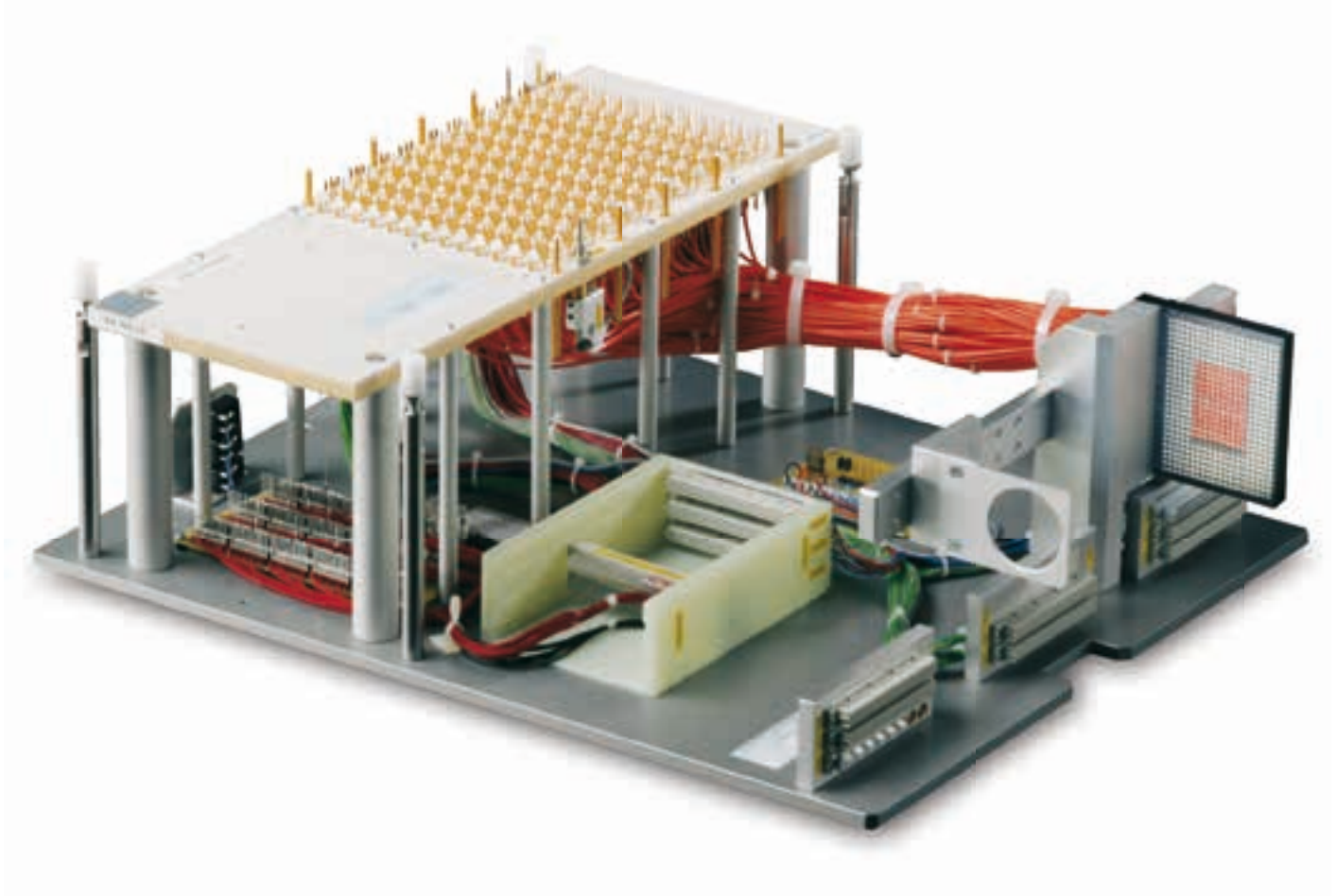

The testing demand as per specification:

For an In-Circuit Test electrically stimulated SMD-LEDs on a defined matrix surface are to be optically transferred using optical beam waveguides. This matrix is viewed with an LCD camera, which detects defect LEDs using an image-processing program. In addition, electrical devices are to be contacted using springloaded Test Probes and wired to a defined Intermediate Interface. When they have passed the test, the individual PC-Boards on the panel are to be marked with Marking Units, which engrave a circle.

The realization:

The optical beam waveguides are fixed and bundled in the Probe Plate underneath the LEDs by means of special open-ended Receptacles and fed into the matrix field in a pre-defined position. The „good“ marking is carried out by means of an electrically driven hardened marking bit, which is also mounted in the Probe Plate, and applies a circular mark.

Because the Panel is conveyed fully automatically in a production line, the testing location of the Panel must be checked and verified. To avoid mechanical damage of individual components of the Test Station, Test Probes with through-plungers are assembled in the Probe Plate. In the case of misalignment, the plunger activates a sensor signal and the stroke movement of the Test Station is immediately halted.

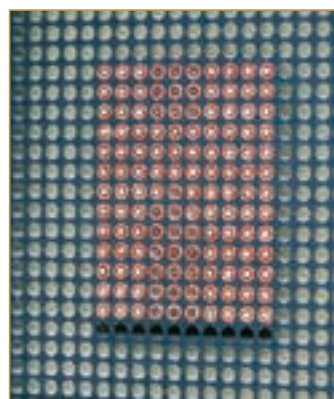

*Details of transfer using
Optical Beam Waveguides*

INGUN Test Fixtures and Accessories

Manual Test Fixtures	7–28	Vacuum Test Fixtures	34–55
Pneumatic Test Fixtures	29–33	Accessories (Excerpt)	56–61

Manual Test Fixtures according to Series

Series	Page	Series	Page
ATS 160	8	MA 2111/D/H/S-5/LI	10
ATS 160/ESD	8	MA 2111/D/H/S-5/RE	10
ATS 2009	9	MA 2112/D/H/S-7	11
ATS 2009/ESD	9	MA 2112/D/H/S-7/GR 2270/71	12, 46
ATS 2009/FR4	9	MA 2112/D/H/S-7/GR 228x 15/07	12, 46
ATS 2109/S-5	9	MA 2112/D/H/S-7/GR 228x 15/15	12, 46
ATS 2109/S-5/ESD	9	MA 2112/D/H/S-7/HG	11
ATS 2109/S-5/FR4	9	MA 2112/D/H/S-7/HG/GR 2270/71	12, 46
ATS 2110	18	MA 2112/D/H/S-7/HG/KT-ITA-21	12, 48
ATS 2011	10, 15	MA 2112/D/H/S-7/HG/Pylon 9,6	12, 42, 47
ATS 2011/ESD	10, 15	MA 2112/D/H/S-7/MAC-Panel Titan Hz	12
ATS 2011/FR4	10, 15	MA 2112/D/H/S-7/MTS 100	12, 36
ATS 2011/HF	10, 15	MA 2112/D/H/S-7/MTS 300	12, 36
ATS 2111/S-5	10, 15	MA 2112/D/H/S-7/Pylon 9,6	12, 42, 47
ATS 2111/S-5/ESD	10, 15	MA 2112/D/H/S-7/Reinhardt VG12	12, 41
ATS 2111/S-5/FR4	10, 15	MA 2112/D/H/S-7/VPC-G12-12	12, 48
ATS 2111/S-5/HF	10, 15	MA 2112/D/H/S-7/VPC-S6	12, 48
ATS 2012	11	MA 2112/F/H/S-7/Aeroflex 4200/4250	12, 35
ATS 2012/ESD	11	MA 2112/F/H/S-7/TD 88xx-M	12, 45
ATS 2012/FR4	11	MA 2112/F/H/S-7/TD 88xx-S	12, 45
ATS 2012/HF	11	MA 2112/S-7/Spec 3030	12, 43
ATS 2112/S-7	11	MA 2113/D/H/S-10	13
ATS 2112/S-7/ESD	11	MA 2113/D/H/S-10/Agilent i 1000	14, 40
ATS 2112/S-7/FR4	11	MA 2113/D/H/S-10/GR 2270/71	14, 46
ATS 2112/S-7/HF	11	MA 2113/D/H/S-10/GR 228x 15/07	14, 46
ATS 2112/S-7/SN	11, 51	MA 2113/D/H/S-10/HG	13
ATS 2112-2/S-7	17	MA 2113/D/H/S-10/HG/GR 2270/71	14, 46
ATS 2013	13	MA 2113/D/H/S-10/HG/Pylon 9,6	14, 42, 47
ATS 2013/ESD	13	MA 2113/D/H/S-10/MTS 300	14, 36
ATS 2013/FR4	13	MA 2113/D/H/S-10/Pylon 9,6	14, 42, 47
ATS 2013/HF	13	MA 2113/D/H/S-10/Reinhardt VG12	14, 41
ATS 2113/S-10	13	MA 2113/D/H/S-10/TD 88xx-M	14, 45
ATS 2113/S-10/ESD	13	MA 2113/D/H/S-10/TD 88xx-S	14, 45
ATS 2113/S-10/FR4	13	MA 2113/D/H/S-10/VPC-G12-12	14, 48
ATS 2113/S-10/HF	13	MA 2113/D/H/S-10/VPC-G12-18	14, 48
ATS 2113-2/S-10	17	MA 2113/F/H/S-10/Aeroflex 4200/4250	14, 35
ATS 2014	16	MA 2113/S-10/Spec 3030	14, 43
ATS 2014/ESD	16	MA 2113T/D/H/2x S-5	15
ATS 2014/FR4	16	MA 2113T/D/H/2x S-5/GR 2270/71	16, 46
ATS 2114/S-10	16	MA 2113T/D/H/2x S-5/GR 228x 15/07	16, 46
ATS 2114/S-10/ESD	16	MA 2113T/D/H/2x S-5/HG	15
ATS 2114/S-10/FR4	16	MA 2113T/D/H/2x S-5/MTS 300	16, 36
KTE 130	18	MA 2113T/D/H/2x S-5/Pylon 9,6	16, 42, 47
KTE 135	18	MA 2113T/D/H/2x S-5/TD 88xx-M	16, 45
KTE 2130	18	MA 2113T/D/H/2x S-5/TD 88xx-S	16, 45
KTE 2135	18	MA 2114/D/H/S-10	16
MA 160	8	Start-up Kit MA 160	8
MA 2109/D/H/S-5	9	Start-up Kit MA 21xx	18
MA 2111/D/H/S-5	10	Spare Part Kits Gas Pressure Springs	18
MA 2111/D/H/S-5/HG	10	Spare Part Kits Contact Springs	18

Headquarter

INGUN Germany

Subsidiaries

INGUN Benelux
INGUN China
INGUN India
INGUN Mexico
INGUN Switzerland
INGUN UK
INGUN USA

Europe

Austria
Benelux
Bosnia-Herzegovina
Croatia
Czech Republic
Denmark
Estonia
Finland
France
Germany
Hungary
Italy
Norway
Poland
Portugal
Romania
Serbia
Slovenia
Slovak Republic
Spain
Sweden
Switzerland
Turkey
United Kingdom

Asia

China
Hong Kong
India
Israel
Japan
Korea
Malaysia
Taiwan
Thailand
Vietnam

Africa

South Africa
Tunisia

Australia

Australia
New Zealand

America

Argentina
Brazil
Canada
Mexico
USA

The addresses of the International Agencies
can be found under www.ingun.com

ingun[®]

INGUN Prüfmittelbau GmbH

Max-Stromeyer-Straße 162

78467 Konstanz

Germany

Tel. +49 7531 8105-0

Fax +49 7531 8105-65

info@ingun.com

www.ingun.com